

DeltaSol[®] BS/4

(Version 2)

RESOL[®]

Solar controller

Manual for the
specialised craftsman

Installation

Operation

Functions and options

Troubleshooting



48005962

Thank you for buying this RESOL product.
Please read this manual carefully to get the best performance from this unit.
Please keep this manual carefully.

en

Manual

www.resol.com

Safety advice

Please pay attention to the following safety advice in order to avoid danger and damage to people and property.

Instructions

Attention must be paid to the valid local standards, regulations and directives!

Information about the product

Proper usage

The solar controller is designed for electronically controlling standard solar thermal systems in compliance with the technical data specified in this manual.

Improper use excludes all liability claims.

CE Declaration of Conformity

The product complies with the relevant directives and is therefore labelled with the CE mark. The Declaration of Conformity is available upon request, please contact RESOL.



Note

Strong electromagnetic fields can impair the function of the controller.

→ Make sure the controller as well as the system are not exposed to strong electromagnetic fields.

Target group

These instructions are exclusively addressed to authorised skilled personnel.

Only qualified electricians are allowed to carry out electrical works.

Initial commissioning must be effected by the system installer or qualified personnel named by the system installer.

Description of symbols

WARNING! Warnings are indicated with a warning triangle!



→ They contain information on how to avoid the danger described.

Signal words describe the danger that may occur, when it is not avoided.

- **WARNING** means that injury, possibly life-threatening injury, can occur.
- **ATTENTION** means that damage to the appliance can occur.



Note

Notes are indicated with an information symbol.

→ Arrows indicate instruction steps that should be carried out.

Disposal

- Dispose of the packaging in an environmentally sound manner.
- At the end of its working life, the product must not be disposed of as urban waste. Old appliances must be disposed of by an authorised body in an environmentally sound manner. Upon request we will take back your old appliances bought from us and guarantee an environmentally sound disposal of the devices.



Subject to technical change. Errors excepted.

The RESOL controller for standard solar thermal systems.

The DeltaSol® BS controller provides a clear operating concept and is equipped with the illuminated combined display with system-monitoring. Flashing symbols for

sensors, pumps and valves enable an immediate allocation of temperatures, temperature differences and active actuators. Thus, adjusting and monitoring the solar system is quick and easy.

Contents

1 Overview	4	5 Commissioning	18
2 Installation	5	6 Channel overview	20
2.1 Mounting.....	5	6.1 Display channels.....	20
2.2 Electrical connection.....	6	6.2 Adjustment channels.....	23
2.3 Data communication / Bus.....	7	7 Troubleshooting	31
2.4 System overview.....	7	8 Accessories	34
2.5 Systems.....	8	8.1 Sensors and measuring instruments.....	35
3 Operation and function	16	8.2 VBus® accessories.....	35
3.1 Buttons.....	16	8.3 Interface adapters.....	35
4 System-Monitoring-Display	16	9 Index	36
4.1 System screen.....	17		
4.2 Other indications.....	17		

1 Overview

- 3 basic systems to choose from
- Drainback option
- Heat quantity measurement
- Tube collector function, thermal disinfection function
- Commissioning menu
- Unit °F and °C selectable
- HE pump control via adapter

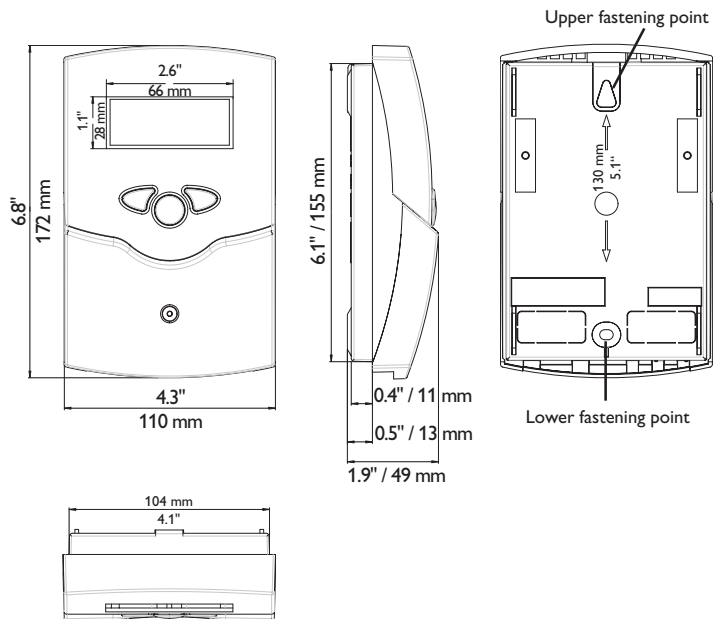

Technical data

Inputs: 4 Pt1000 temperature sensors

Outputs: 2 semiconductor relays

Switching capacity: 1 (1) A 240 V~ (semiconductor relay)

Total switching capacity: 2 A 240 V~

Power supply: 100–240 V~ (50–60 Hz)

Supply connection: type Y attachment

Standby: 0.74 W

Temperature controls class: I

Energy efficiency contribution: 1 %

Mode of operation: type 1.C.Y action

Rated impulse voltage: 2.5 kV

Data interface: RESOL VBus®

VBus® current supply: 35 mA

Functions: function control, operating hours counter, tube collector function, heat quantity measurement and pump speed control

Housing: plastic, PC-ABS and PMMA

Mounting: wall mounting, also suitable for mounting into patch panels

Indication / Display: System-Monitoring-Display for visualisation of systems, 16-segment and 7-segment display, 8 symbols for indication of system status and operating control lamp

Operation: 3 buttons at the front of the housing

Protection type: IP 20 / DIN EN 60529

Protection class: II

Ambient temperature: 0... 40 °C

Degree of pollution: 2

Dimensions: 172 x 110 x 49 mm

2 Installation

2.1 Mounting

WARNING! Electric shock!



Upon opening the housing, live parts are exposed!

→ **Always disconnect the device from power supply before opening the housing!**



Note

Strong electromagnetic fields can impair the function of the controller.

→ Make sure the controller as well as the system are not exposed to strong electromagnetic fields.

The unit must only be located in dry interior rooms.

The controller must additionally be supplied from a double pole switch with contact gap of at least 3 mm.

Please pay attention to separate routing of sensor cables and mains cables.

In order to mount the device to the wall, carry out the following steps:

- Unscrew the crosshead screw from the cover and remove it along with the cover from the housing.
- Mark the upper fastening point on the wall. Drill and fasten the enclosed wall plug and screw leaving the head protruding.
- Hang the housing from the upper fastening point and mark the lower fastening point (centres 130 mm).
- Insert lower wall plug.
- Fasten the housing to the wall with the lower fastening screw and tighten.
- Carry out the electrical wiring in accordance with the terminal allocation (see page 6).
- Put the cover on the housing.
- Attach with the fastening screw.

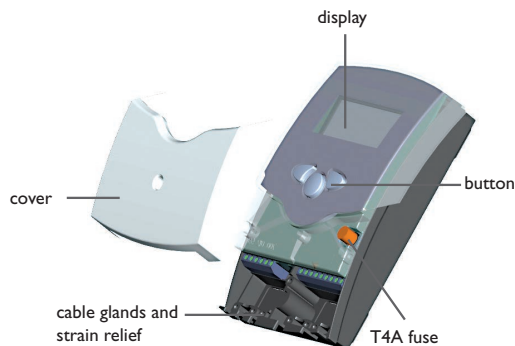

2.2 Electrical connection

WARNING! Electric shock!



Upon opening the housing, live parts are exposed!

→ **Always disconnect the device from power supply before opening the housing!**

ATTENTION! ESD damage!



Electrostatic discharge can lead to damage to electronic components!

→ **Take care to discharge properly before touching the inside of the device!**



Note

Connecting the device to the power supply must always be the last step of the installation!



Note

It must be possible to disconnect the device from the mains at any time.

→ Install the mains plug such that it is accessible at any time.

→ If this is not possible, install a switch that can be accessed.

Do not use the device if it is visibly damaged!

The power supply of the device must be 100 ... 240 V~ (50 ... 60 Hz). Attach flexible cables to the housing with the enclosed strain relief and the corresponding screws.

The controller is equipped with 2 semiconductor relays to which a load such as a pump, a valve, etc. can be connected:

- Relay 1
 - 18 = Conductor R1
 - 17 = Neutral conductor N
 - 13 = Grounding terminal ⚡
- Relay 2
 - 16 = Conductor R2
 - 15 = Neutral conductor N
 - 14 = Grounding terminal ⚡



Note

The pump speed must be set to 100% when auxiliary relays or valves are connected.

The **mains connection** is at the following terminals:

19 = Neutral conductor N

20 = Conductor L

12 = Grounding terminal ⚡

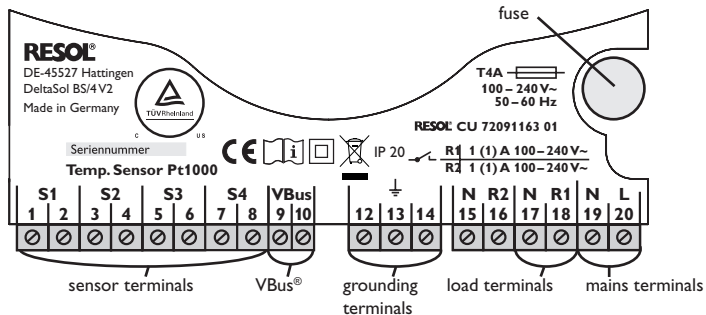

Connect the **temperature sensors** (S1 to S4) to the corresponding terminals with either polarity:

1/2 = Sensor 1 (e. g. collector sensor)

3/4 = Sensor 2 (e. g. store sensor)

5/6 = Sensor 3 (e. g. store sensor top)

7/8 = Sensor 4 (e. g. return sensor)

2.3 Data communication/Bus

The controller is equipped with the **RESOL VBus**[®] for data transfer and energy supply to external modules. The connection is to be carried out at the terminals marked **VBus** (any polarity).

One or more **RESOL VBus**[®] modules can be connected via this data bus, such as:

- RESOL DL2 Datalogger
- RESOL DL3 Datalogger
- VBus[®]/PWM interface adapter

Furthermore, the controller can be connected to a PC or integrated into a network via the RESOL VBus[®]/USB or VBus[®]/LAN interface adapter (not included). Different solutions for visualisation and remote parameterisation are available on the RESOL website www.resol.com.



Note

More accessories on page 34.

2.4 System overview

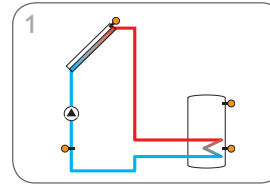

Standard solar system (page 8)

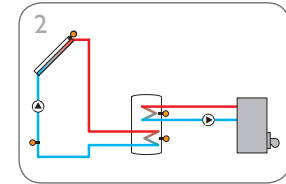

Solar system with afterheating (page 10)

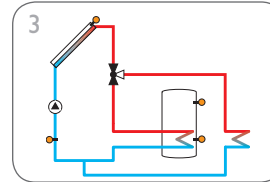

Standard solar system with heat dump (page 14)

2.5 Systems

Arrangement 1:

The controller calculates the temperature difference between collector sensor S1 and store sensor S2. If the difference is larger than or identical to the adjusted switch-on temperature difference (DTO), the solar pump will be activated by the relay, and the store will be loaded until the switch-off temperature difference (DTF) or the maximum store temperature (SMX) is reached.

Sensors S3 and S4 can optionally be connected for measurement purposes. S3 can optionally be used as the reference sensor for the store emergency shutdown option (OSEM).

If heat quantity measurement (OHQM) is activated, S4 is to be used as the return sensor.

If the drainback option (ODB) is activated, relay 2 can be used for activating a booster pump. For this purpose, the booster function (OBST) has to be activated.

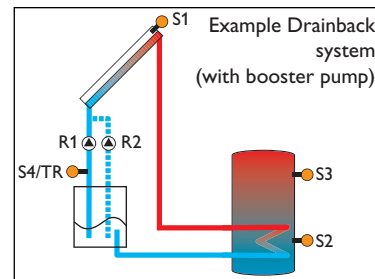
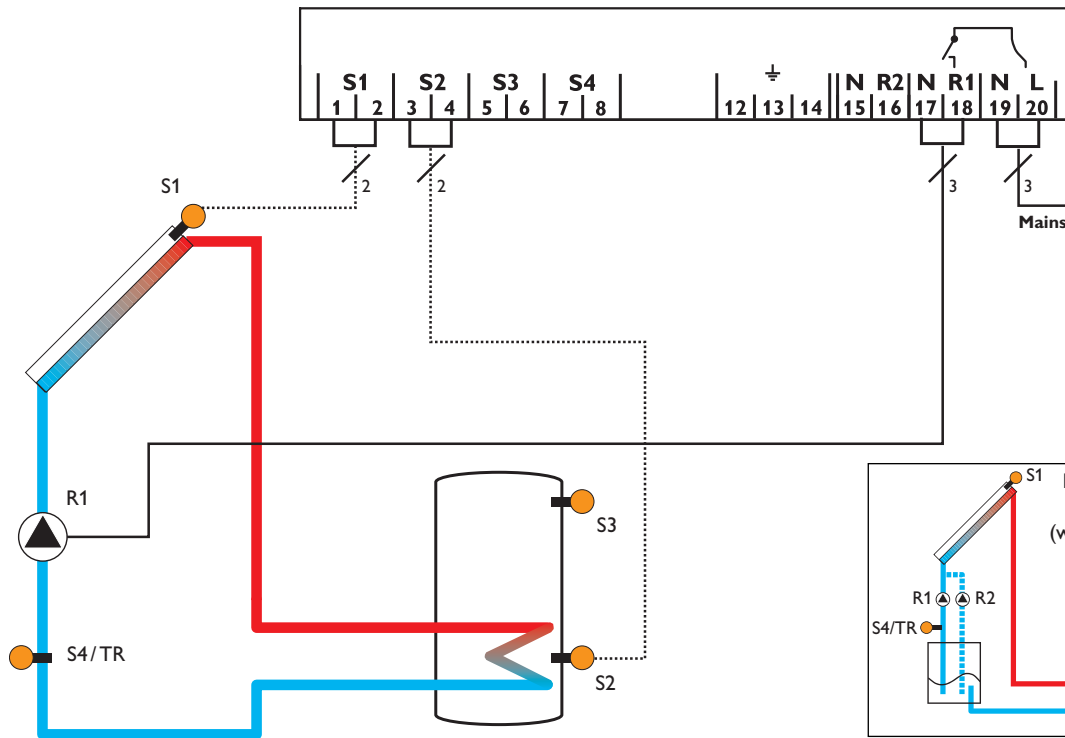
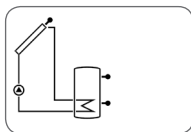

Display channels			
Channel	Description	Connection terminal	Page
INIT	x* ODB initialisation active	-	20
FLL	x* ODB filling time active	-	20
STAB	x* ODB stabilisation in progress	-	20
COL	x Temperature collector	S1	20
TST	x Temperature store	S2	20
S3	x Temperature sensor 3	S3	21
S4	x Temperature sensor 4	S4	21
TR	x* Temperature return sensor	S4	21
n %	x Speed R1	R1	21
hP	x Operating hours R1	R1	22
hP1	x* Operating hours R1 (if OBST is activated)	R1	22
hP2	x* Operating hours R2 (if OBST is activated)	R2	22
kWh	x* Heat quantity in kWh	-	21
MWh	x* Heat quantity in MWh	-	21
TIME	x Time	-	22

Adjustment channels			
Channel	Description	Factory setting	Page
Arr	x System	1	22
DTO	x Switch-on temperature difference	6.0 K [12.0 °Ra]	23
DTF	x Switch-off temperature difference	4.0 K [8.0 °Ra]	23
DT S	x Set temperature difference	10.0 K [20.0 °Ra]	23
RIS	x Rise R1	2 K [4 °Ra]	24
nMN	x Minimum speed	30%	24
S MX	x Maximum store temperature	60 °C [140 °F]	24
OSEM	x Store emergency shutdown option	OFF	24
EM	Collector emergency temperature	130 °C [270 °F]	25
	Collector emergency temperature if ODB is activated:	95 °C [200 °F]	25
OCC	x Collector cooling option	OFF	25
CMX	x* Maximum collector temperature	110 °C [230 °F]	25
OSYC	x System cooling option	OFF	25
DTCO	x* Switch-on temperature difference cooling	20.0 K [40.0 °Ra]	25
DTCF	x* Switch-off temperature difference cooling	15.0 K [30.0 °Ra]	25
OSTC	x Store cooling option	OFF	25
OHOL	x* Holiday cooling option	OFF	25
THOL	x* Holiday cooling temperature	40 °C [110 °F]	25
OCN	x Collector minimum limitation option	OFF	26

Adjustment channels			
Channel	Description	Factory setting	Page
CMN	x* Minimum collector temperature	10 °C [50 °F]	26
OCF	x Antifreeze option	OFF	26
CFR	x* Antifreeze temperature	4.0 °C [40.0 °F]	26
OTC	x Tube collector option	OFF	27
TCST	x* OTC starting time	07:00	27
TCEN	x* OTC ending time	19:00	27
TCRU	x* OTC runtime	30 s	27
TCIN	x* OTC standstill interval	30 min	27
OHQM	x Heat quantity measurement option	OFF	28
FMAX	x* Maximum flow rate	6.0 l	28
MEDT	x* Antifreeze type	1	28
MED%	x* Antifreeze concentration (only if MEDT = propylene or ethylene glycol)	45%	28
ODB	x Drainback option	OFF	28
tDTO	x* ODB switch-on condition - time period	60 s	29
tFLL	x* ODB filling time	5.0 min	29
tSTB	x* ODB stabilisation time	2.0 min	29
OBST	s* Option booster function	OFF	29
MAN1	x Manual mode R1	Auto	29
MAN2	x Manual mode R2	Auto	29
ADA1	x HE pump control	OFF	29
LANG	x Language	dE	29
UNIT	x Temperature unit	°C	29
RESE	x Reset - back to factory settings		30
#####	Version number		

Legend:

Symbol	Description
x	Channel is available
x*	Channel is available, if the corresponding option is activated.

Arrangement 2:

The controller calculates the temperature difference between collector sensor S1 and store sensor S2. If the difference is larger than or identical to the adjusted switch-on temperature difference (DT O), the solar pump will be activated by relay 1, and the store will be loaded until the switch-off temperature difference (DT F) or the maximum store temperature (S MX) is reached.

Sensor S3 is used for a thermostat function which operates relay 2 for afterheating or heat dump purposes when the adjusted thermostat switch-on temperature (AHO) is reached. This function can optionally be combined with up to three adjustable time frames.

S3 can optionally be used as the reference sensor for the thermal disinfection function (OTD).

Sensor S4 can optionally be connected for measurement purposes. If heat quantity measurement (OHQM) is activated, S4 is to be used as the return sensor.

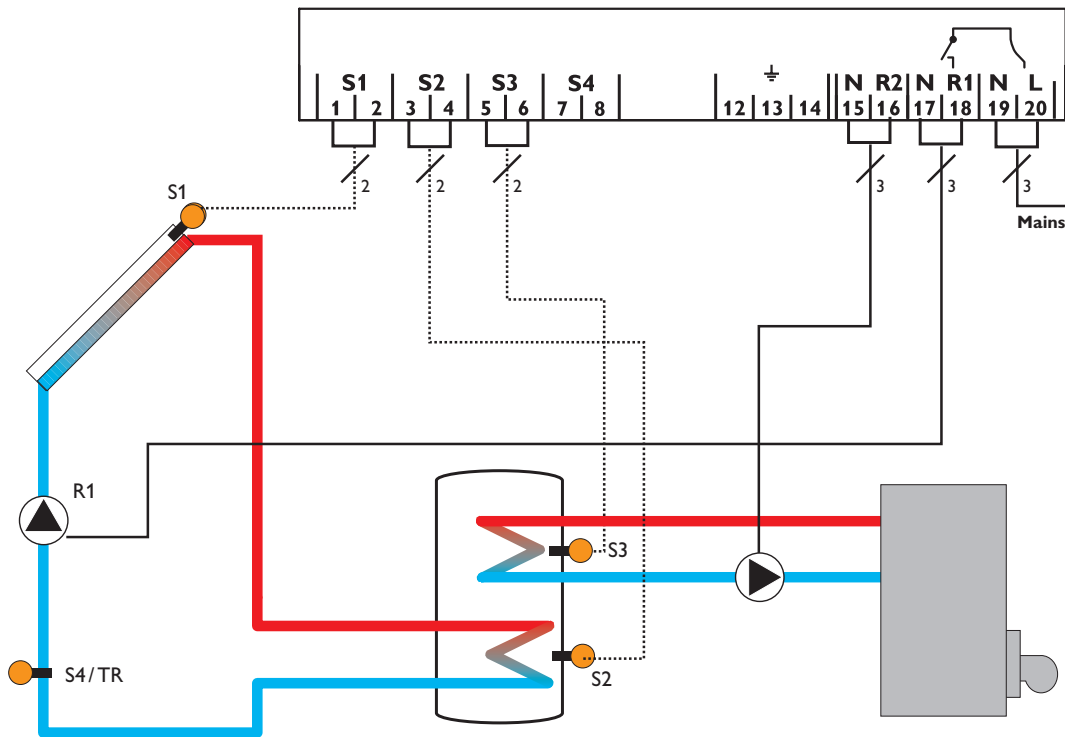
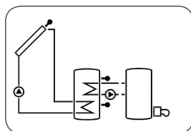

Display channels

Channel	Description	Connection terminal	Page
INIT	x* ODB initialisation active	-	20
FLL	x* ODB filling time active	-	20
STAB	x* ODB stabilisation in progress	-	20
COL	x Temperature collector	S1	20
TSTB	x Temperature store 1 base	S2	20
TSTT	x Temperature store 1 top	S3	20
TDIS	s* Thermal disinfection temperature (thermal disinfection)	S3	20
S4	x Temperature sensor 4	S4	21
TR	x* Temperature return sensor	S4	21
n1 %	x Speed R1	R1	21
h P1	x Operating hours R1	R1	22
h P2	x Operating hours R2	R2	22
kWh	x* Heat quantity in kWh	-	21
MWh	x* Heat quantity in MWh	-	21
CDIS	s* Countdown of monitoring period (thermal disinfection)	-	21
SDIS	s* Display of starting time	-	22
DDIS	s* Heating period display	-	22
TIME	x Time	-	22

Adjustment channels

Channel	Description	Factory setting	Page
Arr	x System	2	22
DTO	x Switch-on temperature difference	6.0 K [12.0 °Ra]	23
DTF	x Switch-off temperature difference	4.0 K [8.0 °Ra]	23
DT S	x Set temperature difference	10.0 K [20.0 °Ra]	23
RIS	x Rise R1	2 K [4 °Ra]	24
n1MN	x Minimum speed R1	30%	24
S MX	x Maximum store temperature	60 °C [140 °F]	24
OSEM	x Store emergency shutdown option	OFF	24
EM	x Collector emergency temperature	130 °C [270 °F]	25
	Collector emergency temperature if ODB is activated:	95 °C [200 °F]	25
OCC	x Collector cooling option	OFF	25
CMX	x* Maximum collector temperature	110 °C [230 °F]	25
OSYC	x System cooling option	OFF	25
DTCO	x* Switch-on temperature difference cooling	15.0 K [30.0 °Ra]	25
DTCF	x* Switch-off temperature difference cooling	15.0 K [30.0 °Ra]	25
OSTC	x Store cooling option	OFF	25
OHOL	x* Holiday cooling option	OFF	25
THOL	x* Holiday cooling temperature	40 °C [110 °F]	25
OCN	x Collector minimum limitation option	OFF	26

Adjustment channels

Channel	Description	Factory setting	Page
CMN	x* Minimum collector temperature	10 °C [50 °F]	26
OCF	x Antifreeze option	OFF	26
CFR	x* Antifreeze temperature	4.0 °C [40.0 °F]	26
OTC	x Tube collector option	OFF	27
TCST	x* OTC starting time	07:00	27
TCEN	x* OTC ending time	19:00	27
TCRU	x* OTC runtime	30 s	27
TCIN	x* OTC standstill interval	30 min	27
OHQM	x Heat quantity measurement option	OFF	28
FMAX	x* Maximum flow rate	6.0 l	28
MEDT	x* Antifreeze type	1	28
MED%	x* Antifreeze concentration	45%	28
AH O	s Switch-on temperature for thermostat 1	40 °C [110 °F]	12
AHF	s Switch-off temperature for thermostat 1	45 °C [120 °F]	12
t1 O	s Thermostat switch-on time 1	00:00	12
t1 F	s Thermostat switch-off time 1	00:00	12
t2 O	s Thermostat switch-on time 2	00:00	12
t2 F	s Thermostat switch-off time 2	00:00	12
t3 O	s Thermostat switch-on time 3	00:00	12
t3 F	s Thermostat switch-off time 3	00:00	12
ODB	x Drainback option	OFF	28
tDTO	x* ODB switch-on condition - time period	60 s	29
tFLL	x* ODB filling time	5.0 min	29
tSTB	x* ODB stabilisation time	2.0 min	29
OTD	s Thermal disinfection option	OFF	13
PDIS	s* Monitoring period	01:00	13
DDIS	s* Heating period	01:00	13
TDIS	s* Disinfection temperature	60 °C [140 °F]	13
SDIS	s* Starting time	00:00	13
MAN1	x Manual mode R1	Auto	29
MAN2	x Manual mode R2	Auto	29
ADA1	x HE pump control	OFF	29
LANG	x Language	dE	29
UNIT	x Temperature unit	°C	29
RESE	x Reset - back to factory settings		29
#####	Version number		

Legend:

Symbol	Description
x	Channel is available
x*	Channel is available, if the corresponding option is activated.

System-specific functions

The following adjustments are used for the specific functions in system 2. The channels described are not available in any other system.

Thermostat function

Afterheating

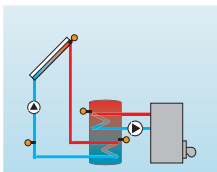

Use of surplus energy

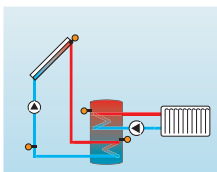

The thermostat function works independently from the solar operation and can be used for using surplus energy or for afterheating.

- **AHO < AHF**
thermostat function for afterheating
- **AHO > AHF**
thermostat function for using surplus energy

The symbol  will be shown on the display if the second relay output is activated.

Reference sensor for the thermostat function is S3.



AH O

Thermostat switch-on temperature

Adjustment range: 0.0 ... 95.0 °C

[30.0 ... 200.0 °F]

Factory setting: 40.0 °C [110.0 °F]



AHF

Thermostat switch-off temperature

Adjustment range: 0.0 ... 95.0 °C

[30.0 ... 200.0 °F]

Factory setting: 45.0 °C [120.0 °F]

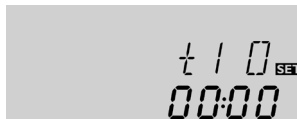

t1 O, t2 O, t3 O

Thermostat switch-on time

Adjustment range: 00:00 ... 23:45

Factory setting: 00:00



t1 F, t2 F, t3 F

Thermostat switch-off time

Adjustment range: 00:00 ... 23:45

Factory setting: 00:00

In order to block the thermostat function for a certain period, there are 3 time frames t1 ... t3.

If the thermostat function is supposed to run from 06:00 a.m. to 09:00 a.m. only, adjust **t1 O** to 06:00 a.m. and **t1 F** to 09:00 a.m.

If the switch-on and switch-off times of a time frame are set to an identical value, the time frame will be inactive. If all time frames are set to 00:00, the thermostat function is solely temperature dependent (factory setting).

Thermal disinfection of the upper DHW zone



OTD
Therm. disinfection function
Adjustment range: OFF/ON
Factory setting: OFF



PDIS
Monitoring period
Adjustment range:
0 ... 30:0 ... 24 h (dd:hh)
Factory setting: 01:00

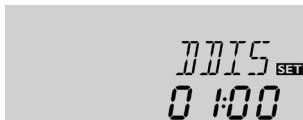

DDIS
Disinfection period
Adjustment range:
0:00 ... 23:59 (hh:mm)
Factory setting: 01:00

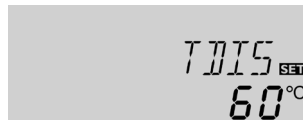

TDIS
Disinfection temperature
Adjustment range:
0 ... 95 °C [30 ... 200 °F]
Factory setting: 60 °C [140 °F]

This function helps to contain the spread of Legionella in DHW stores by systematically activating the afterheating.

For thermal disinfection, the temperature at the reference sensor will be monitored. Protection is ensured when, during the monitoring period, the disinfection temperature is continuously exceeded for the entire disinfection period.

The monitoring period starts as soon as the temperature at the reference sensor falls below the disinfection temperature. When the monitoring period ends, the allocated reference relay activates the afterheating. The disinfection period starts, if the temperature at the allocated sensor exceeds the disinfection temperature.

Thermal disinfection can only be completed when the disinfection temperature is exceeded for the duration of the disinfection period without any interruption.

Starting time delay

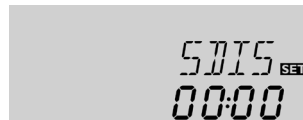

SDIS
Starting time
Adjustment range: 0:00 ... 24:00 (time)
Factory setting: 00:00

If the starting delay option is activated, a starting time for the thermal disinfection with starting delay can be adjusted. The activation of the afterheating is then delayed until that starting time after the monitoring period has ended.

If the monitoring period ends, for example, at 12:00 o'clock, and the starting time has been set to 18:00, the reference relay will be energised with a delay of 6 hours at 18:00 instead of 12:00 o'clock.



Note

If the thermal disinfection option is activated, the display channels **TDIS**, **CDIS**, **SDIS** and **DDIS**.

Arrangement 3:

The controller calculates the temperature difference between collector sensor S1 and store sensor S2. If the difference is larger than or identical to the adjusted switch-on temperature difference (DT O), the solar pump will be activated by relay R1, and the store will be loaded until the switch-off temperature difference (DT F) or the maximum store temperature (S MX) is reached.

If the maximum collector temperature (CMX) is reached, the solar pump will be activated by R1 and the 3-port valve by R2 in order to direct the surplus energy to a heat dump. For safety reasons, excess heat dump will only take place as long as the store temperature is below the non-adjustable shutdown temperature of 95 °C [200 °F].

Sensors S3 and S4 can optionally be connected for measurement purposes. S3 can optionally be used as the reference sensor for the store emergency shutdown option (OSEM).

If heat quantity measurement (OHQM) is activated, S4 is to be used as the return sensor.

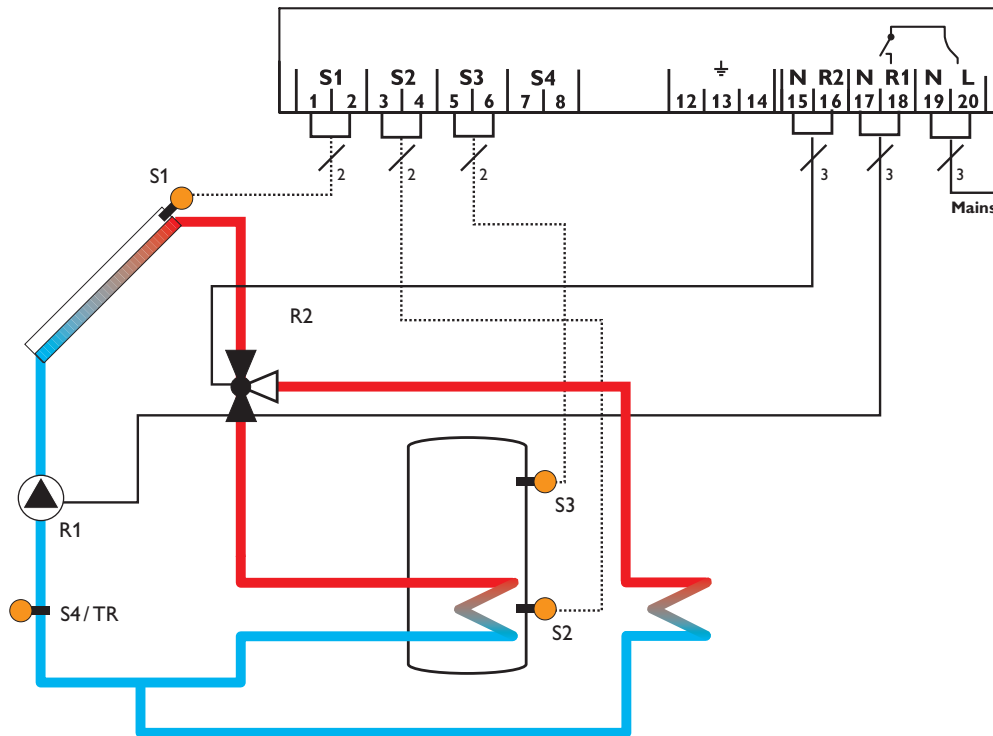
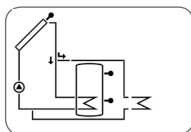

Display channels				
Channel		Description	Connection terminal	Page
COL	x	Temperature collector	S1	20
TST	x	Temperature store	S2	20
S3	x	Temperature sensor 3	S3	21
S4	x	Temperature sensor 4	S4	21
TR	x*	Temperature return sensor	S4	21
n %	x	Speed relay	R1	21
h P1	x	Operating hours R1	R1	22
h P2	x	Operating hours R2	R2	22
kWh	x*	Heat quantity in kWh	-	21
MWh	x*	Heat quantity in MWh	-	21
TIME	x	Time	-	22

Adjustment channels				
Channel		Description	Factory setting	Page
Arr	x	System	3	23
DT O	x	Switch-on temperature difference	6.0 K [12.0 °Ra]	23
DT F	x	Switch-off temperature difference	4.0 K [8.0 °Ra]	23
DT S	x	Set temperature difference	10.0 K [20.0 °Ra]	23
RIS	x	Rise R1	2 K [4 °Ra]	24
nMN	x	Minimum speed	30%	24
S MX	x	Maximum store temperature	60 °C [140 °F]	24
OSEM	x	Store emergency shutdown option	OFF	24
EM	x	Collector emergency temperature	130 °C [270 °F]	25
CMX	s	Maximum collector temperature	110 °C [230 °F]	25
OCN	x	Collector minimum limitation option	OFF	26
CMN	x*	Minimum collector temperature	10 °C [50 °F]	26
OCF	x	Antifreeze option	OFF	27
CFR	x*	Antifreeze temperature	4.0 °C [40.0 °F]	27
OTC	x	Tube collector option	OFF	27
TCST	x*	OTC starting time	07:00	27
TCEN	x*	OTC ending time	19:00	27
TCRU	x*	OTC runtime	30 s	27
TCIN	x*	OTC standstill interval	30 min	27
OHQM	x	Heat quantity measurement option	OFF	28
FMAX	x*	Maximum flow rate	6.0 l	28
MEDT	x*	Antifreeze type	1	28
MED%	x*	Antifreeze concentration (only if MEDT = propylene or ethylene glycol)	45%	28
MAN1	x	Manual mode R1	Auto	29
MAN2	x	Manual mode R2	Auto	29
ADA1	x	HE pump control	OFF	30
LANG	x	Language	dE	30
UNIT	x	Temperature unit	°C	30
RESE	x	Reset - back to factory settings		30
#####		Version number		

Legend:

Symbol	Description
x	Channel is available
x*	Channel is available, if the corresponding option is activated.

3 Operation and function

3.1 Buttons

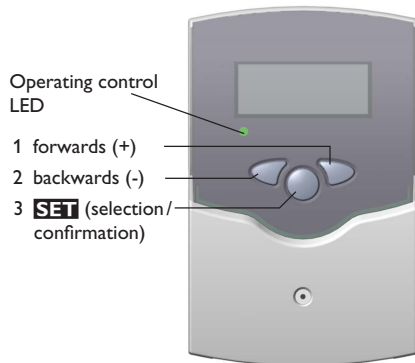

Operating control LED

- 1 forwards (+)
- 2 backwards (-)
- 3 **SET** (selection/confirmation)

The controller is operated via the 3 push buttons below the display.

Button 1 (+) - Scrolling forwards, increasing adjustment values.

Button 2 (-) - Scrolling backwards, reducing adjustment values.

Button 3 (OK) - confirming/selecting.

During normal operation, display channels will be displayed.

➔ In order to scroll between display channels, press buttons 1 and 2.

Access to adjustment channels:

➔ Use button 1 in order to scroll to the last display channel, then press and hold down button 1 for approx. 2 s.

If an **adjustment channel** is shown on the screen, **SET** will be displayed on the right-hand side next to the channel name.

➔ Press button 3 in order to select an adjustment channel.

SET starts flashing.

➔ Adjust the desired value with buttons 1 and 2.

➔ Briefly press button 3.

SET permanently appears, the adjusted value has been saved.

4 System-Monitoring-Display

System-Monitoring-Display

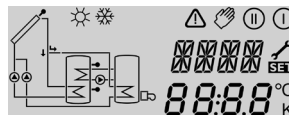

The System-Monitoring-Display consists of 3 blocks: channel display, tool bar and system screen.

Channel display

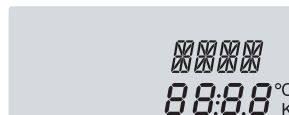

The channel display consists of 2 lines. The upper display line is an alphanumeric 16-segment display. In this line, mainly channel names and menu items are displayed. In the lower 16-segment display, values are displayed.

Tool bar

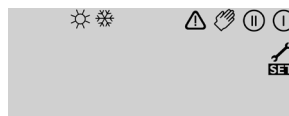

The additional symbols in the tool bar indicate the current system state.

4.1 System screen

The system selected is indicated in the System-Monitoring-Display. It consists of several system component symbols which are – depending on the current status of the system – either flashing, permanently shown or not indicated.

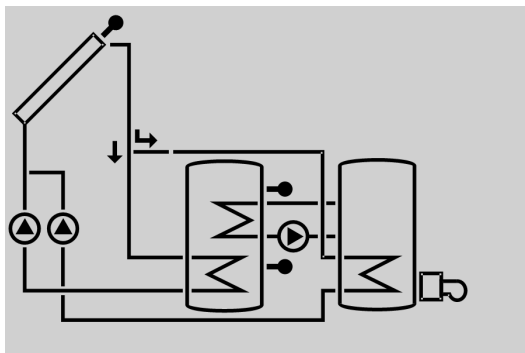

Collector
with collector sensor



Temperature sensor



Store
with heat exchanger



Pump



3-port valve
Only the flow direction or current switching position is indicated.



Afterheating
with burner symbol

4.2 Other indications

System screen

- Pumps are flashing when the corresponding relay is switched on.
- Sensor symbols are flashing, if the corresponding sensor display channel is selected.
- Sensors are flashing quickly in the case of a sensor fault.
- Burner symbol is flashing if the afterheating is active.

Operating control LED

Green: Everything OK
 Red/green flashing: Initialisation active
 Red flashing: Manual mode
 Sensor fault (sensor symbol is flashing quickly)

Permanently shown	Flashing	Status indications:
ⓘ		Relay 1 active
Ⓜ		Relay 2 active
⏏		Maximum store temperature exceeded
	⚠ + ⏏	Store emergency shutdown active
	⚠	Collector emergency shutdown active
ⓘ	⏏	Collector cooling active
ⓘ	⏏	System cooling active
ⓘ + ⏏		Store cooling active
⏏	⚠	Holiday cooling option activated
ⓘ + ⏏	⚠	Holiday cooling active
	❄	Collector minimum limitation active
❄		Antifreeze function activated
ⓘ	❄	Antifreeze function active
👤 + ⓘ	⚠	Manual mode relay 1 ON
👤 + Ⓜ	⚠	Manual mode relay 2 ON
👤	⚠	Manual mode relay 1/2 OFF
🔧	⚠	Sensor fault

5 Commissioning

- 1 forwards (+)
- 2 backwards (-)
- 3 **SET** (selection / confirmation)

→ Connect the device to the mains.

The controller runs an initialisation phase in which the operating control LED flashes red/green.

When the controller is commissioned or when it is reset, it will run a commissioning menu. The commissioning menu leads the user through the most important adjustment channels needed for operating the system.

Operation

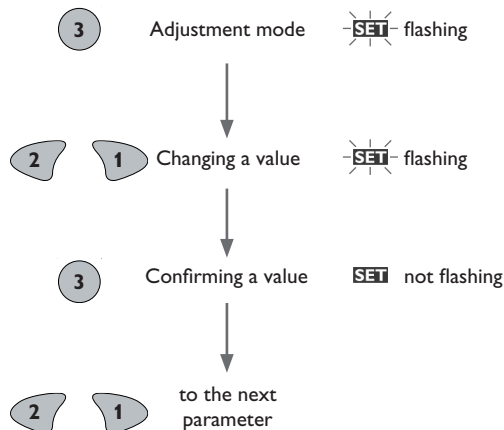

Commissioning

1. Language

→ Adjust the desired menu language.

LANG

Language selection

Selection: dE, En, Fr

Factory setting: dE

2. Temperature unit

→ Adjust the desired unit.

UNIT

Temperature unit

Selection: °F, °C

Factory setting: °C

3. Time

→ Adjust the clock time.

First of all adjust the hours, then the minutes.

TIME

Real time clock

4. Arrangement

→ Adjust the desired system.

For a detailed description of the systems to choose from, see page 8.

Arr

System selection

Adjustment range: 1 ... 3

Factory setting: 1

If the system selection is changed later on, any previous adjustments which have been made in the other channels will be lost. Therefore, changing the system is always followed by a security enquiry.



Commissioning

Only confirm the security enquiry if you are sure that you wish to change the system selection.

Security enquiry

→ In order to confirm the security enquiry, press button 3.

5. Maximum store temperature

→ Adjust the maximum store temperature.

S MX

Adjustment range: 4 ... 95 °C [40 ... 200 °F]

Factory setting: 60 °C [140 °F]



Note

The controller is also equipped with a non-adjustable emergency shutdown, deactivating the system if the store reaches 95 °C [200 °F].

6. Minimum speed

→ Adjust the minimum speed for the corresponding pump.

nMN

Speed control

Adjustment range: 30 ... 100%

Factory setting: 30



Note

The pump speed must be set to 100% when auxiliary relays or valves are connected.

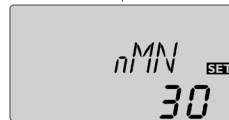
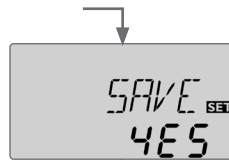

Confirmation

Completing the commissioning menu.

After the last channel of the commissioning menu has been adjusted and confirmed, the controller asks for confirmation of the adjustments.

→ In order to confirm the adjustments made in the commissioning menu, press button 3.

The controller is then ready for operation and normally the factory settings will give close to optimum operation.



Note

The adjustments carried out during commissioning can be changed anytime in the corresponding adjustment channel. Additional functions and options can also be activated or deactivated (see page 23).

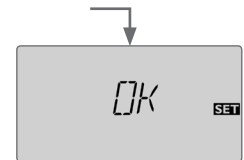

6 Channel overview

6.1 Display channels



Note

The display and adjustment channels as well as the adjustment ranges depend on the system selected, the functions and options as well as on the system components connected to the controller.

Display of drainback time periods

Initialisation



INIT
60

INIT

ODB initialisation active

Indicates the time adjusted in **tD_{TO}**, running backwards.

Filling time



FLL
05:00

FLL

ODB filling time active

Indicates the time adjusted in **tFLL**, running backwards.

Stabilisation



STAB
02:00

STAB

ODB stabilisation in progress

Indicates the time adjusted in **tSTB**, running backwards.

Display of collector temperatures



COL
85°C

COL

Collector temperature

Display range: -40 ... +260 °C [-40 ... +500 °F]

Indicates the collector temperature.

Display of store temperatures



TST
43.9°C

TST, TSTB, TSTT, TDIS

Store temperatures

Display range: -40 ... +260 °C [-40 ... +500 °F]

Indicates the store temperatures.

- TST : Store temperature
- TSTB : Store temperature base
- TSTT : Store temperature top
- TDIS : Thermal disinfection temperature
(replaces TSTT if, during thermal disinfection, the heating period DDIS is active)

TSTB, TSTT and TDIS are only available if Arr = 2

Indication of sensors 3 and 4

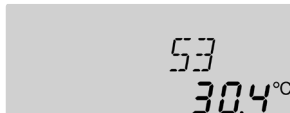

S3, S4

Sensor temperatures

Display range: -40 ... +260 °C [-40 ... +500 °F]

Indicates the current temperature at the corresponding additional sensor (without control function).

- S3: Temperature at sensor 3 (only if Arr = 1 or 3)
- S4: Temperature at sensor 4



Note

S3 and S4 will only be indicated if the temperature sensors are connected to the corresponding terminals.

Indication of return temperature



TR

Return temperature

Display range: -40 ... +260 °C [-40 ... +500 °F]

If the heat quantity measurement is activated, the temperature at sensor S4 will be indicated as TR.

Indication of current pump speed



n%

Current pump speed

Display range: 30 ... 100 %

Indicates the current pump speed of the corresponding pump.

Display of heat quantity



kWh/MWh

Heat quantity in kWh/MWh

Display channel

Indicates the heat quantity produced in the system. For this purpose, the heat quantity measurement option has to be enabled. The flow rate as well as the values of the reference sensors flow and return are used for calculating the heat quantity supplied. It is shown in kWh in the **kWh** channel and in MWh in the **MWh channel**. The overall heat quantity results from the sum of both values.

The accumulated heat quantity can be set back to zero. As soon as one of the display channels of the heat quantity is selected, the symbol **SET** is displayed.

➔ In order to access the reset mode of the counter, press button 3 for approx. 2 s.

SET starts flashing and the heat quantity value will be set back to zero.

➔ In order to finish the reset process, press button 3.

In order to interrupt the reset process, do not press any button for about 5 s. The display returns to the display mode.

Indication of thermal disinfection



CDIS

Countdown monitoring period

Display range: 0 ... 30:0 ... 24 (dd:hh)

If the thermal disinfection option (**OTD**) is activated and the monitoring period is in progress, the remaining time is displayed as **CDIS** (in hours and minutes), counting backwards.



SDIS
17:30

SDIS

Display of starting time

Display range: 00:00 ... 24:00 (hh:mm)

If the thermal disinfection option (**OTD**) is activated and a starting delay time has been adjusted, the adjusted starting time is displayed as **SDIS** (flashing).



DDIS
00:59

DDIS

Indication of heating period

Display range: 00:00 ... 24:00 (hh:mm)

If the thermal disinfection option (**OTD**) is activated and the heating period is in progress, the remaining time is displayed as **CDIS** (in hours and minutes), counting backwards.



TIME ^{SET}
11:36

TIME

Indicates the current clock time.

- ➔ In order to adjust the hours, press button 3 for approx. 2 s.
- ➔ Set the hours by pressing buttons 1 and 2.
- ➔ In order to adjust the minutes, press button 3.
- ➔ Set the minutes by pressing buttons 1 and 2.
- ➔ In order to save the adjustments, press button 3.

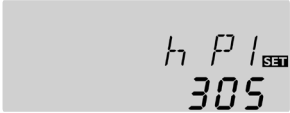
Operating hours counter

h P1 ^{SET}
305

h P/h P1/h P2

Operating hours counter

Display channel

The operating hours counter accumulates the operating hours of the corresponding relays (**hP/hP1/hP2**).

Full hours are displayed.

The accumulated operating hours can be set back to zero. As soon as the operating hours channel is selected, the symbol ^{SET} is displayed.

➔ In order to access the reset mode of the counter, press button 3 for approx. 2 s.

^{SET} starts flashing and the operating hours value will be set back to zero.

➔ In order to finish the reset process, press button 3.

In order to interrupt the reset process, do not press any button for about 5 s. The display returns to the display mode.

6.2 Adjustment channels

System selection



Arr

System selection

Adjustment range: 1 ... 3

Factory setting: 1

In this channel, a pre-defined system can be selected. Each system has a set of pre-programmed settings that can be individually changed.

If the system selection is changed later on, any previous adjustments which have been made in the other channels will be lost. Therefore, changing the system is always followed by a security enquiry.

Only confirm the security enquiry if you are sure that you wish to change the system selection.



Security enquiry

→ In order to confirm the security enquiry, press button 3.

ΔT control

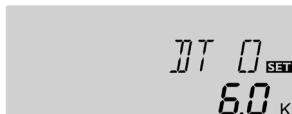

DT O

Switch-on temperature difference

Adjustment range: 1.0 ... 20.0 K [2.0 ... 40.0 °Ra]

Factory setting: 6.0 K [12.0 °Ra]

The controller works as a standard differential controller. If the temperature reaches or exceeds the switch-on temperature difference, the pump switches on. When the temperature difference reaches or falls below the adjusted switch-off temperature difference, the respective relay switches off.



Note

The switch-on temperature difference must be at least 0.5 K [1 °Ra] higher than the switch-off temperature difference.



DT F

Switch-off temperature difference

Adjustment range: 0.5 ... 19.5 K [1.0 ... 39.0 °Ra]

Factory setting: 4.0 K [8.0 °Ra]



Note

When the drainback option **ODB** is activated, the values of the parameters **DT O**, **DT F** and **DT S** will be adapted to values suiting drainback systems:

DT O = 10 K [20 °Ra]

DT F = 4 K [8 °Ra]

DT S = 15 K [30 °Ra]

Adjustments previously made in these channels will be overridden and have to be entered again if **ODB** is deactivated later on.

Speed control



DT S

Set temperature difference

Adjustment range: 1.5 ... 30.0 K [3.0 ... 60.0 °Ra]

Factory setting: 10.0 K [20.0 °Ra]



Note

For pump speed control, the operating mode of the relay 1 must be set to **Auto** (adjustment channel **MAN1**).

**RIS**

Rise

Adjustment range: 1 ... 20 K [2 ... 40 °Ra]

Factory setting: 2 K [4 °Ra]

If the temperature difference reaches or exceeds the switch-on temperature difference, the pump switches on at 100% speed for 10 s. Then, the speed is reduced to the minimum pump speed value.

If the temperature difference reaches the adjusted set value, the pump speed increases by one step (10%). The response of the controller can be adapted via the parameter Rise. Each time the difference increases by the adjustable rise value, the pump speed increases by 10% until the maximum pump speed of 100% is reached. If the temperature difference decreases by the adjustable rise value, pump speed will be decreased by one step.

**Note**

The set temperature difference must be at least 0.5 K [1 °Ra] higher than the switch-on temperature difference.

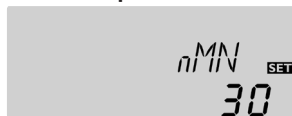
Minimum speed**nMN**

Minimum speed

Adjustment range: 30 ... 100%

Factory setting: 30%

If ODB is activated: 50%

A relative minimum pump speed can be allocated to the output R1 via the adjustment channel **nMN**.

**Note**

When loads which are not speed-controlled (e. g. valves) are used, the value **nMN** must be set to 100% to deactivate pump speed control.

Maximum store temperature**S MX**

Maximum store temperature

Adjustment range: 4 ... 95 °C [40 ... 200 °F]

Arr 3: 4 ... 90 °C [40 ... 190 °F]

Factory setting: 60 °C [140 °F]

If the store temperature reaches the adjusted maximum temperature, the store will no longer be loaded in order to avoid damage caused by overheating. A hysteresis of 2 K [4 °Ra] is set for the maximum store temperature.

If the maximum store temperature is exceeded, ☼ is displayed.

**Note**

If the collector cooling or the system cooling function is activated, the adjusted maximum store temperature may be exceeded. In order to prevent system damage, the controller is also equipped with an integrated store emergency shutdown, deactivating the system if the store reaches 95 °C [200 °F].

Store emergency shutdown**OSEM**

Store emergency shutdown option

Adjustment range: ON, OFF

Factory setting: OFF

This option is used for activating the internal store emergency shutdown for an upper store sensor. If the temperature at the reference sensor exceeds 95 °C [200 °F], the store will be blocked and loading will be stopped until the temperature falls below 90 °C [190 °F].

**Note**

S3 is used as the reference sensor.

Collector emergency shutdown



EM

Collector limit temperature

Adjustment range: 80 ... 200 °C [170 ... 390 °F]

Factory setting: 130 °C [270 °F]

When the collector temperature exceeds the adjusted collector limit temperature, the solar pump (R1) switches off in order to protect the system components against overheating (collector emergency shutdown). If the collector limit temperature is exceeded, Δ is displayed (flashing).



Note

If the drainback option **ODB** is activated, the adjustment range of **EM** is changed to 80 ... 120 °C [170 ... 250 °F]. The factory setting in that case is 95 °C [200 °F].

Cooling functions

In the following the 3 cooling functions – collector cooling, system cooling and store cooling – are described in detail. The following note is valid for all 3 cooling functions:



Note

The cooling functions will not become active as long as solar loading is possible.

Collector cooling



OCC

Collector cooling option

Adjustment range: OFF/ON

Factory setting: OFF



CMX

Maximum collector temperature

Adjustment range:

70 ... 160 °C [150 ... 320 °F]

Factory setting: 110 °C [230 °F]

The collector cooling function keeps the collector temperature within the operating range by heating the store. If the store temperature reaches 95 °C [200 °F] the function will switch off for safety reasons.

If the store temperature exceeds the adjusted maximum store temperature, the solar system is switched off. If the collector temperature increases to the adjusted maximum collector temperature, the solar pump is activated until the collector temperature falls below the maximum collector temperature. The store temperature may then exceed the maximum temperature, but only up to 95 °C [200 °F] (emergency shutdown of the store).

If the collector cooling function is active, \odot and \star are displayed (flashing).



Note

This function will only be available if the system cooling function (**OSYC**) is deactivated.



Note

In system 3, the parameter **CMX** is available without the **OCC** function. In system 3, **CMX** is used for setting the activation temperature for the heat dump function. No other switch-on condition is needed in that case.

System cooling

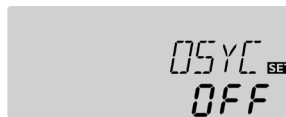

OSYC

System cooling option

Adjustment range: OFF/ON

Factory setting: OFF



DTCD

Switch-on temperature difference

Adjustment range:

1.0 ... 30.0 K [2.0 ... 60.0 °Ra]

Factory setting: 20.0 K [40.0 °Ra]



DTCF

Switch-off temperature difference

Adjustment range:

0.5 ... 29.5 K [1.0 ... 59.0 °Ra]

Factory setting: 15.0 K [30.0 °Ra]

The system cooling function aims to keep the solar system operational for a longer time. The function overrides the maximum store temperature to provide thermal relief of the collector field and the heat transfer fluid on hot days.

If the store temperature is higher than the adjusted maximum store temperature and the switch-on temperature difference **DTCO** is reached, the solar pump remains switched on or will be switched on. Solar loading is continued until either the temperature difference falls below the adjusted value **DTCF** or the collector limit temperature is reached.

If the system cooling function is active,  and  are displayed (flashing).



Note

This function will only be available, if the collector cooling function (OCC) is deactivated.

Store cooling

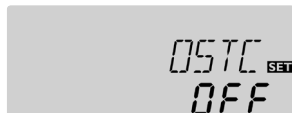

OSTC

Store cooling option

Adjustment range: OFF/ON

Factory setting: OFF



OHOL

Holiday cooling option

Adjustment range: OFF/ON

Factory setting: OFF



THOL

Holiday cooling temperature

Adjustment range:

20 ... 80 °C [70 ... 175 °F]



Factory setting: 40 °C [110 °F]

When the store cooling function is activated, the controller aims to cool down the store during the night in order to prepare it for solar loading on the following day.

If the adjusted maximum store temperature **SMX** is exceeded and the collector temperature falls below the store temperature, the system will be reactivated in order to cool down the store. Cooling will continue until the store temperature has fallen below the adjusted maximum store temperature (**SMX**) again. A hysteresis of 2 K [4 °Ra] is set for the store cooling function.

Reference threshold temperature differences for the store cooling function are **DTO** and **DTF**.

If no DHW consumption is expected for a longer period of time, the additional holiday cooling option **OHOL** can be activated in order to extend the store cooling function. The adjustable temperature **THOL** then replaces the maximum store temperature (**SMX**) as the switch-off temperature for the store cooling function.

When the holiday cooling function is activated,  and  (flashing) are shown on the display.

If the holiday cooling function is active, ,  and  are displayed (flashing).

Collector minimum limitation

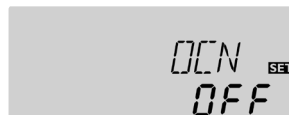

OCN

Collector minimum limitation option

Adjustment range: OFF/ON

Factory setting: OFF



CMN

Minimum collector temperature

Adjustment range:

10.0 ... 90.0 °C [50.0 ... 190.0 °F]

Factory setting: 10.0 °C [50.0 °F]

If the collector minimum limitation option is activated, the pump (R1) will only be switched on if the adjustable minimum collector temperature is exceeded. The minimum temperature prevents the pump from being switched on too often at low collector temperatures. A hysteresis of 5 K [10 °Ra] is set for this function.

If the collector minimum limitation is active,  is displayed (flashing).



Note

If **OSTC** or **OCF** is active, the collector minimum limitation will be overridden. In that case, the collector temperature may fall below **CMN**.

Antifreeze function



OCF

Antifreeze option

Adjustment range: OFF/ON

Factory setting: OFF



CFR

Antifreeze temperature

Adjustment range:

-40.0 ... +10.0 °C [-40.0 ... +50.0 °F]

Factory setting: + 4.0 °C [+ 40.0 °F]



TCEN

Tube collector function ending time

Adjustment range: 00:00 ... 23:45

Factory setting: 19:00



TRCU

Tube collector function runtime

Adjustment range: 5 ... 500 s

Factory setting: 30 s

The antifreeze function activates the loading circuit between the collector and the store when the temperature falls below the adjusted antifreeze temperature. This will protect the fluid against freezing or coagulating. If the adjusted antifreeze temperature is exceeded by 1 K [2 °Ra], the loading circuit will be deactivated.

If the antifreeze function is activated, ❄️ is displayed. If the antifreeze function is active, ⓪ and ❄️ are displayed (flashing).



Note

Since this function uses the limited heat quantity of the store, the antifreeze function should only be used in regions with few days of temperatures around the freezing point.

The antifreeze function will be suppressed if the store temperature falls below +5 °C [+40 °F] in order to protect the store from frost damage.



TCIN

Tube collector function standstill interval

Adjustment range: 1 ... 60 min

Factory setting: 30 min

This function is used for improving the switch-on behaviour in systems with non-ideal sensor positions (e.g. with some tube collectors). This function operates within an adjusted time frame. It activates the collector circuit pump for an adjustable runtime between adjustable standstill intervals in order to compensate for the delayed temperature measurement.

If the runtime is set to more than 10 seconds, the pump will be run at 100% for the first 10 s of the runtime. For the remaining runtime, the pump will be run at the adjusted minimum speed. If the collector sensor is defective or the collector is blocked, this function is suppressed or switched off.



Note

If the drainback option **ODB** is activated, **TRCU** will not be available. In that case, the runtime will be determined by the parameters **tFLL** and **tSTB**.

Tube collector function



OTC

Tube collector option

Adjustment range: OFF/ON

Factory setting: OFF



TCST

Tube collector function starting time

Adjustment range: 00:00 ... 23:45

Factory setting: 07:00

Heat quantity measurement

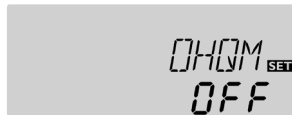

OHQM

Heat quantity measurement
Adjustment range: OFF/ON
Factory setting: OFF



FMAX

Flow rate in l/min
Adjustment range: 0.5 ... 100.0
Factory setting: 6.0

Heat transfer fluid:

0: Water
1: Propylene glycol
2: Ethylene glycol
3: Tyfocor® LS/G-LS



MEDT

Heat transfer fluid
Adjustment range: 0 ... 3
Factory setting: 1



MED%

Antifreeze concentration
in Vol-% (MED% is not indicated when
MEDT 0 or 3 is used.)
Adjustment range: 20 ... 70 %
Factory setting: 45 %

If OHQM is activated, the heat quantity gained can be calculated and displayed. Heat quantity measurement is possible if a flowmeter is used.

The heat quantity balancing (estimation) uses the difference between the flow and return temperatures and the entered flow rate (at 100% pump speed).

- ➔ Read the flow rate (l/min) and adjust it in the **FMAX** channel.
- ➔ Adjust the antifreeze type and concentration of the heat transfer fluid in the channels **MEDT** and **MED%**.



Note

If the system 3 has been selected and **OHQM** is activated, heat quantity measurement will be interrupted when the 3-port valve switches to the heat dump.

Drainback option



Note

A drainback system requires additional components such as a holding tank. The drainback option should only be activated if all components required are properly installed.



Note

The drainback option is only available in systems 1 and 2.

In a drainback system, the heat transfer fluid will flow into a holding tank if solar loading does not take place. The drainback option initiates the filling process if solar loading is about to start. If the drainback option is activated, the following adjustment can be made.

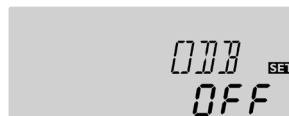

ODB

Drainback option
Adjustment range: OFF/ON
Factory setting: OFF



Note

If the drainback option is activated, the cooling functions and the antifreeze function will not be available. If one or more than one of these functions have been activated before, they will be deactivated again as soon as **ODB** is activated. They will remain deactivated, even if **ODB** is deactivated later on.



Note

If the drainback option **ODB** is activated, the factory settings of the parameters **nMN**, **DTO**, **DTF** and **DTS** will be adapted to values suiting drainback systems.

Additionally, the adjustment range and the factory setting of the collector emergency shutdown will change. Adjustments previously made in these channels will be overridden and have to be entered again if the drainback option is deactivated later on.

Time period – switch-on condition

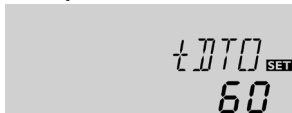

tDTC

Time period – switch-on condition

Adjustment range: 1 ... 100 s

Factory setting: 60 s

The parameter **tDTC** is used for adjusting the time period during which the switch-on condition must be permanently fulfilled.

Filling time



tFLL

Filling time

Adjustment range: 1.0 ... 30.0 min

Factory setting: 5.0 min

The filling time can be adjusted using the parameter **tFLL**. During this period, the pump runs at 100% speed.

Stabilisation

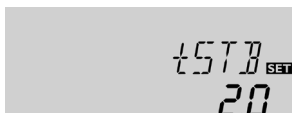

tSTB

Stabilisation

Adjustment range: 1.0 ... 15.0 min

Factory setting: 2.0 min

The parameter **tSTB** is used for adjusting the time period during which the switch-off condition will be ignored after the filling time has ended.

Booster function

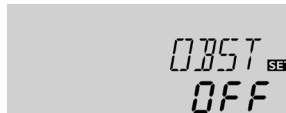

OBST

Booster function

Adjustment range: ON/OFF

Factory setting: OFF

This function is used for switching on a second pump when filling the solar system. When solar loading starts, R2 is energised in parallel to R1. After the filling time has elapsed, R2 switches off.



Note

The booster function is available in system 1 only. The booster function will only be available if the drainback option has been activated.

Operating mode

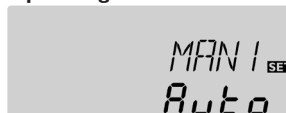

MAN1/MAN2

Operating mode

Adjustment range: OFF, Auto, On

Factory setting: Auto

For control and service work, the operating mode of the relays can be manually adjusted. For this purpose, select the adjustment value **MAN1** (for R1) or **MAN2** (for R2) in which the following adjustments can be made:

• MAN1/MAN2

Operating mode

OFF : Relay off Δ (flashing) + ☞

Auto : Relay in automatic operation

ON : Relay on Δ (flashing) + ☞ + ① / ②



Note

Always adjust the operating mode back to **Auto** when the control and service work is completed. Normal operation is not possible in manual mode.

HE pump control



ADA1 SET
OFF

ADA1

HE pump control via adapter
Adjustment range: ON, OFF
Factory setting: OFF

This option is used for controlling a high-efficiency pump via a VBus®/PWM adapter. The power supply of the pump is carried out via the semiconductor relay R1. For pump speed control with activated ADA1 option, the relay is switched on or off (no burst control). Temperature dependent speed information is transmitted via the VBus®. The relay will remain deactivated for 1 hour after its switch-off conditions have been fulfilled (pump protection).

Language



LANG SET
En

LANG

Language selection
Selection: dE, En, Fr
Factory setting: dE

In this adjustment channel the menu language can be selected.

- dE : Deutsch
- En : English
- Fr : French

Unit



UNIT SET
°C

UNIT

Temperature unit selection
Selection: °F, °C
Factory setting: °C

In this adjustment channel, the display unit for temperatures and temperature differences can be selected. The unit can be switched between °C/K and °F/°Ra during operation.

Temperatures and temperature differences in °F and °Ra are displayed without units. If the indication is set to °C, the units are displayed with the values.

Reset

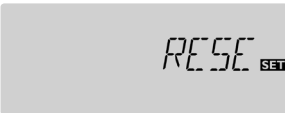

RESE SET

RESE

Reset function

By means of the reset function, all adjustments can be set back to their factory settings.

→ In order to carry out a reset, press button 3.

All adjustments that have previously been made will be lost! For this reason, a security enquiry will appear after the reset function has been selected.

Only confirm the security enquiry if you are sure you want to set back all adjustment to the factory setting.

Security enquiry



SAVE SET
YES

→ In order to confirm the security enquiry, press button 3.



Note

After a reset, the commissioning menu will start again (see page18).

7 Troubleshooting

If a malfunction occurs, the display symbols will indicate an error code:



Operating control LED is permanently off.



Check the power supply of the controller. Is it disconnected?

no

The fuse of the controller could be blown. The fuse holder (which holds the spare fuse) becomes accessible when the cover is removed. The fuse can then be replaced.

yes

Check the supply line and reconnect it.

The symbol  is indicated on the display and the symbol  flashes.

Sensor fault. An error code instead of a temperature is shown on the sensor display channel.

888.8

- 88.8

Cable is broken. Check the cable.

Short circuit. Check the cable.

Disconnected Pt1000 temperature sensors can be checked with an ohmmeter. Please check the resistance values correspond with the table.

°C	°F	Ω	°C	°F	Ω
-10	14	961	55	131	1213
-5	23	980	60	140	1232
0	32	1000	65	149	1252
5	41	1019	70	158	1271
10	50	1039	75	167	1290
15	59	1058	80	176	1309
20	68	1078	85	185	1328
25	77	1097	90	194	1347
30	86	1117	95	203	1366
35	95	1136	100	212	1385
40	104	1155	105	221	1404
45	113	1175	110	230	1423
50	122	1194	115	239	1442

Resistance values of Pt1000 sensors



Note

For answers to frequently asked questions (FAQ) see www.resol.com.

Pump is overheated, but no heat transfer from the collector to the store, flow and return have the same temperature; perhaps also bubbling in the lines.

Air or gas bubbles in the system?

no

yes

Are the valves or the non-return valves defective or is the dirt trap blocked?

yes

Vent the system; increase the system pressure to a static primary pressure of at least plus 0.5 bar [7.25 psi]; if necessary continue to increase the pressure; switch the pump on and off for a short time.

Clean the dirt trap or replace defective component

Pump starts for a short moment, switches off, switches on again, etc.

Temperature difference at the controller too small?

no

yes

Change ΔT_{on} and ΔT_{off} correspondingly.

no

o.k.

Wrong position of collector sensors?

no

yes

Mount the collector sensor at solar flow (warmest collector output); use immersion sleeve of the respective collector.

Plausibility control of the option tube collector function

Pump starts up very late.

Switch-on temperature difference ΔT_{on} too large?

no

yes

Change ΔT_{on} and ΔT_{off} correspondingly.

Non-ideal position of the collector sensor (e. g. flatscrew sensor instead of sensor in immersion sleeves)?

no

yes

Put the solar pump (R1) into the manual mode **On** for a short time during irradiation. Check whether the collector temperature significantly increases.

Minimum limitation active

o.k.

The temperature difference between store and collector increases enormously during operation; the collector circuit cannot dissipate the heat.

Collector circuit pump / zone valve defective?

no

yes

Check or replace, if necessary

Heat exchanger calcified?

no

yes

Decalcify it

Heat exchanger blocked?

no

yes

Clean it

Heat exchanger too small?

yes

Replace with correctly sized one.

Stores cool down at night.

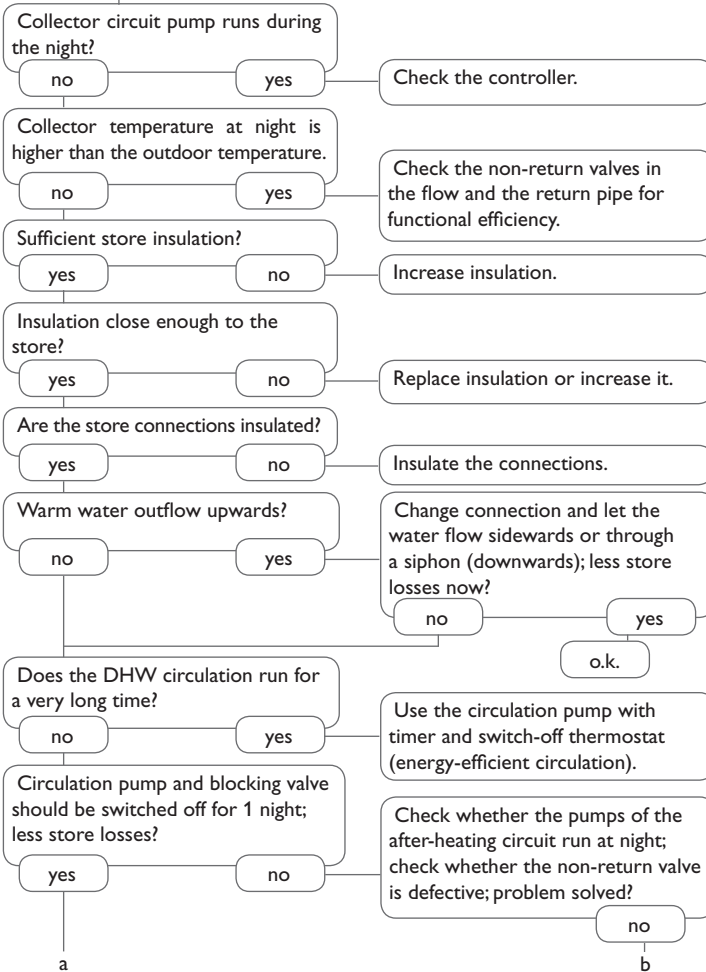

a

b

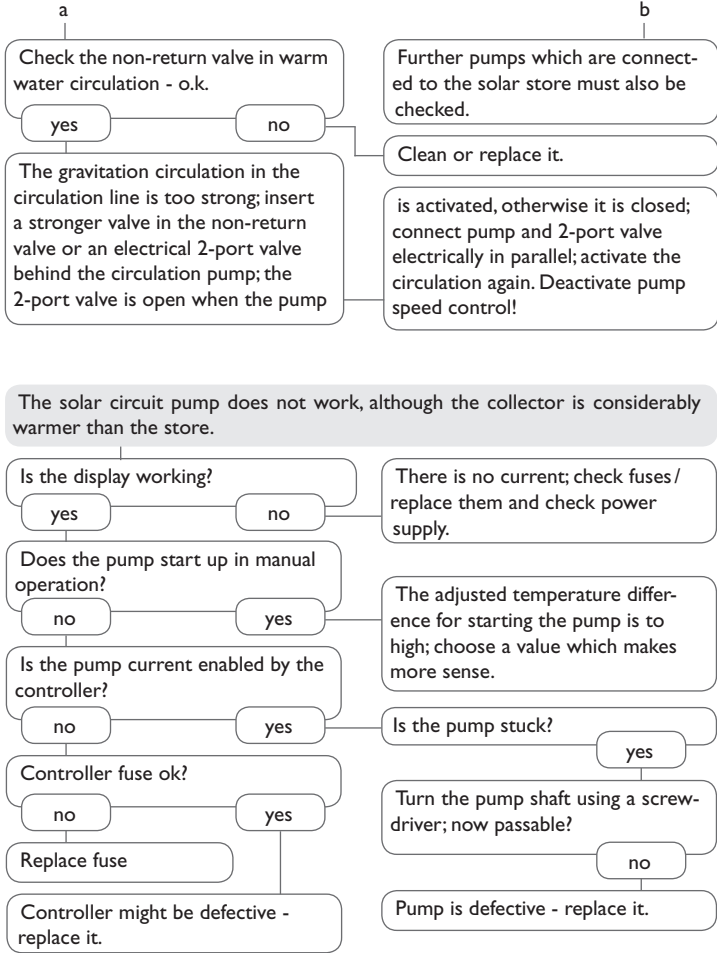

a

b

en
Installation
Operation and function
Commissioning
Indications, functions and options
Messages



Sensors



Overvoltage protection device



SD3 Smart Display / GA3 Large Display



AM1 Alarm Module



DL2 Datalogger



DL3 Datalogger



RESOL VBus® / USB & VBus® / LAN interface adapters

8.1 Sensors and measuring instruments

Temperature sensors

The product range includes high-precision platinum temperature sensors, flatscrew sensors, outdoor temperature sensors, indoor temperature sensors, cylindrical clip-on sensors, also as complete sensors with immersion sleeve.

Order information can be found in our catalogue and on our website.

Overvoltage protection device

In order to avoid overvoltage damage at collector sensors (e. g. caused by local lightning storms), we recommend installing the overvoltage protection RESOL SP10.

8.2 VBus® accessories

SD3 Smart Display

The RESOL Smart Display is designed for simple connection to RESOL controllers with RESOL VBus®. It is used for visualising data issued by the controller: collector temperature, store temperature and energy yield of the solar thermal system. The use of high-efficiency LEDs and filter glass assures a high optical brilliance. An additional power supply is not required.

GA3 Large Display module

The GA3 is a completely mounted large display module for visualisation of collector- and store temperatures as well as the heat quantity yield of the solar system via one 6-digit and two 4-digit 7-segment-displays. An easy connection to all controllers with RESOL VBus® is possible. The front plate is made of antireflective filterglass and is printed with a light-resistant UV-lacquering. The universal RESOL VBus® allows the parallel connection of 8 large displays as well as additional VBus® modules.

AM1 Alarm Module

The AM1 Alarm Module is designed to signal system failures. It is to be connected to the VBus® of the controller and issues an optical signal via the red LED if a failure has occurred. The AM1 also has a relay output, which can e. g. be connected to a building management system (BMS). Thus, a collective error message can be issued in the case of a system failure.

The AM1 Alarm module ensures that occurring failures can be immediately recognised and repaired, even if the system and the controller are difficult to access or located in a remote place. Thus, the reliability and the stable yield of the system are ensured.

DL2 Datalogger

This additional module enables the acquisition and storage of large amounts of data (such as measuring and balance values of the solar system) over a long period of time. System access is possible with just a few clicks via the VBus.net Internet portal. For transmission of the data stored in the internal memory of the DL2 to a PC, an SD card can be used.

The DL2 is appropriate for all controllers with RESOL VBus®. It can be connected directly to a PC or router for remote access and thus enables comfortable system monitoring for yield monitoring or for diagnostics of faults.

DL3 Datalogger

Be it solar thermal, heating or DHW heat exchange controllers – with the DL3 you can easily and conveniently log system data. Get a comprehensive overview of all controllers connected with the large full graphic display.

Transfer data with an SD memory card, or use the LAN interface to view and process data on your PC. System access is possible with just a few clicks via the VBus.net Internet portal.

8.3 Interface adapters

VBus®/USB interface adapter

The VBus®/USB interface adapter is the interface between the controller and a personal computer. With its standard mini USB port it enables a fast transmission of system data for processing, visualising and archiving as well as the parametrisation of the controller via the VBus®. The RESOL ServiceCenter software is included.

VBus®/LAN interface adapter

The VBus®/LAN interface adapter is designed for the direct connection of the controller to a PC or router. It enables easy access to the controller via the local network of the owner. Thus, controller access, system parameterisation and data charting can be effected from every workstation of the network. The VBus®/LAN interface adapter is suitable for all controllers equipped with a RESOL VBus®. The RESOL ServiceCenter software is included.

A
 Accessories..... 34, 35
 Afterheating..... 12
 Antifreeze function..... 27

B
 Booster function 29

C
 Code 31
 Collector cooling..... 25
 Collector emergency shutdown..... 25
 Commissioning 18
 Cooling functions 25

D
 ΔT control 23
 Data communication / Bus 7
 Displays 17
 Drainback option 28

E
 Electrical connection..... 6

H
 Heat quantity measurement..... 28
 HE pump control 30
 Holiday cooling option..... 26

L
 Language..... 30

M
 Manual mode..... 29
 Minimum and maximum temperatures 26
 Minimum collector limitation..... 26
 Minimum collector temperature 26
 Monitoring-Display 16
 Mounting..... 5

O
 Operating mode..... 29

S
 Sensor type..... 21
 Speed control..... 23
 Store cooling..... 26
 System overview 7

T
 Technical data..... 4
 Thermal disinfection..... 13
 Thermostat function 12
 Time..... 18
 Troubleshooting..... 31
 Tube collector function..... 27

U
 Unit..... 30

Distributed by:

RESOL – Elektronische Regelungen GmbH

Heiskampstraße 10
45527 Hattingen / Germany

Tel.: +49 (0) 23 24 / 96 48 - 0

Fax: +49 (0) 23 24 / 96 48 - 755

www.resol.com

info@resol.com

Important note

The texts and drawings in this manual are correct to the best of our knowledge. As faults can never be excluded, please note:

Your own calculations and plans, under consideration of the current standards and directions should only be basis for your projects. We do not offer a guarantee for the completeness of the drawings and texts of this manual - they only represent some examples. They can only be used at your own risk. No liability is assumed for incorrect, incomplete or false information and / or the resulting damages.

Note

The design and the specifications can be changed without notice.

The illustrations may differ from the original product.

Imprint

This mounting- and operation manual including all parts is copyrighted. Another use outside the copyright requires the approval of RESOL – Elektronische Regelungen GmbH. This especially applies for copies, translations, micro films and the storage into electronic systems.

© **RESOL – Elektronische Regelungen GmbH**