

# DeltaSol<sup>®</sup>MX

Beginning with firmware version 2.02

# RESOL<sup>®</sup>

## System controller for complex solar and heating systems

Manual for the specialised craftsman

**Installation**

**Operation**

**Functions and options**

**Troubleshooting**

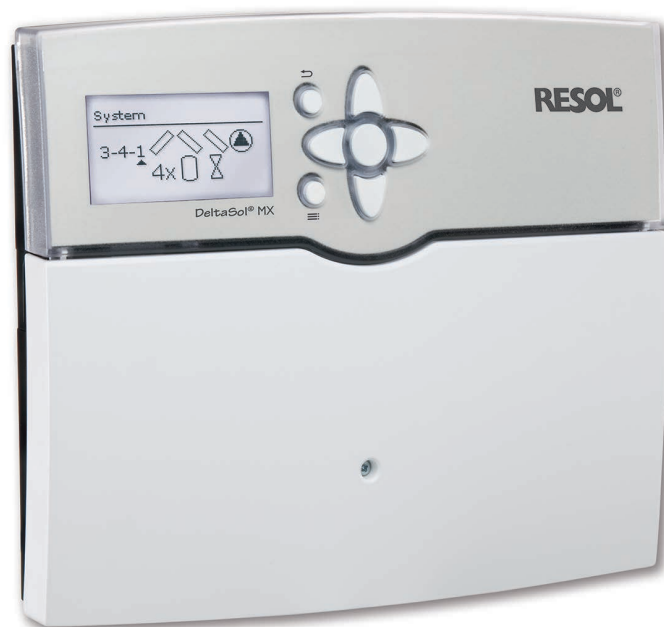

11211447



The Internet portal for easy and secure access to your system data – [www.vbus.net](http://www.vbus.net)

Thank you for buying this RESOL product.

Please read this manual carefully to get the best performance from this unit.

Please keep this manual safe.

en

Manual

[www.resol.com](http://www.resol.com)

## Safety advice

Please pay attention to the following safety advice in order to avoid danger and damage to people and property.

## Instructions

Attention must be paid to the valid local standards, regulations and directives!

## Information about the product

### Proper usage

The system controller is designed for electronically controlling solar thermal systems and heating systems in compliance with the technical data specified in this manual.

Improper use excludes all liability claims.

### CE Declaration of conformity

The product complies with the relevant directives and is therefore labelled with the CE mark. The Declaration of Conformity is available upon request, please contact the manufacturer.



#### Note

Strong electromagnetic fields can impair the function of the controller.

- Make sure the controller as well as the system are not exposed to strong electromagnetic fields.

## Target group

These instructions are exclusively addressed to authorised skilled personnel.

Only qualified electricians should carry out electrical works.

Initial installation must be effected by the system owner or qualified personnel named by the system owner.

## Description of symbols

**WARNING!** Warnings are indicated with a warning triangle!



→ **They contain information on how to avoid the danger described.**

Signal words describe the danger that may occur, when it is not avoided.

- **WARNING** means that injury, possibly life-threatening injury, can occur.
- **ATTENTION** means that damage to the appliance can occur.



#### Note

Notes are indicated with an information symbol.

- Arrows indicate instruction steps that should be carried out.

## Disposal

- Dispose of the packaging in an environmentally sound manner.
- Dispose of old appliances in an environmentally sound manner. Upon request we will take back your old appliances bought from us and guarantee an environmentally sound disposal of the devices.

**Subject to technical change. Errors excepted.**

The *DeltaSol®* MX is the most versatile system controller for complex solar and heating systems in our product range. It is ideal to control a combination of solar and non-solar parts of the system.

Easy combination and parameterisation of pre-programmed functions for several millions of hydraulic variants.

## Contents

<b>1 Overview</b> .....	<b>4</b>	<b>8 Solar</b> .....	<b>47</b>
1.1 Optional functions .....	5	8.1 Basic setting .....	47
<b>2 Installation</b> .....	<b>5</b>	8.2 Optional functions .....	50
2.1 Mounting .....	5	8.3 Function control .....	61
2.2 Electrical connection .....	7	8.4 Holiday function .....	62
2.3 Data communication / Bus .....	8	8.5 Solar expert menu .....	63
2.4 SD card slot .....	8	<b>9 Arrangement</b> .....	<b>63</b>
<b>3 Step-by-step parameterisation</b> .....	<b>9</b>	9.1 Optional functions .....	64
<b>4 Operation and function</b> .....	<b>10</b>	<b>10 Heating</b> .....	<b>73</b>
4.1 Buttons .....	10	10.1 Shared relays .....	73
4.2 Selecting menu points and adjusting values .....	10	10.2 Heating circuits .....	75
4.3 Adjusting the timer .....	12	10.3 Optional functions .....	84
4.4 Adjusting optional functions .....	14	10.4 Screed drying .....	88
<b>4.5 Output selection submenu</b> .....	<b>16</b>	<b>11 HQM</b> .....	<b>89</b>
<b>5 Commissioning</b> .....	<b>19</b>	<b>12 Basic settings</b> .....	<b>90</b>
5.1 Basic systems .....	20	<b>13 SD card</b> .....	<b>91</b>
5.2 Overview of relay and sensor allocation .....	21	<b>14 Manual mode</b> .....	<b>92</b>
<b>6 Main menu</b> .....	<b>44</b>	<b>15 User code</b> .....	<b>93</b>
6.1 Menu structure .....	45	<b>16 Inputs / Modules</b> .....	<b>93</b>
<b>7 Status</b> .....	<b>46</b>	16.1 Modules .....	93
7.1 Measured / Balance values .....	46	16.2 Inputs .....	93
7.2 Solar .....	46	<b>17 Troubleshooting</b> .....	<b>95</b>
7.3 Arrangement .....	46	<b>18 Accessories</b> .....	<b>98</b>
7.4 Heating .....	46	<b>19 Index</b> .....	<b>99</b>
7.5 HQM .....	46		
7.6 Messages .....	46		
7.7 Home screen .....	47		

## 1 Overview

- **14 relay outputs and 12 inputs for Pt1000, Pt500 or KTY temperature sensors**
- **Up to 5 extension modules via RESOLVBus® (45 sensors and 39 relays in total)**
- **Inputs for analogue and digital Grundfos Direct Sensors™**
- **Integrated control of up to 4 high-efficiency pumps via PWM outputs**
- **Data logging, storing, easy transfer of controller adjustments prepared and firmware updates via SD card**
- **Cooling over the heating circuit with condensation detection by means of a dew point switch**
- **Simplified timer, 0-10 V boiler control and DHW preheating**
- **Remote access to the heating circuits with room control unit(s) or the VBus®Touch HC App**
- **Extended optional functions, e.g. solid fuel boiler function with mixer and target temperature control**

### Technical data

**Inputs:** 12 Pt1000, Pt500 or KTY temperature sensor inputs (can optionally be used for remote controls, operating mode switches or potential-free switches), 3 impulse inputs for V40 flowmeters (can optionally be used for Pt1000, Pt500 or KTY temperature sensors, remote controls, operating mode switches or potential-free switches); 1 input for a FlowRotor; 1 CS10 solar cell, 4 Grundfos Direct Sensors™ (2 x analogue, 2 x digital)

**Outputs:** 14 relays, 13 of them semiconductor relays for speed control, 1 potential-free relay, 4 PWM outputs (switchable to 0-10 V)

**PWM frequency:** 512 Hz

**PWM voltage:** 10.5 V

**Switching capacity:**

1 (1) A 240 V~ (semiconductor relay)

4 (2) A 24 V== / 240 V~ (potential-free relay)

**Total switching capacity:** 6.3 A 240 V~

**Power supply:** 100 ... 240 V~ (50 ... 60 Hz)

**Supply connection:** type Y attachment

**Standby:** 0.84 W

**Temperature controls class:** VIII

**Energy efficiency contribution:** 5 %

**Mode of operation:** type 1.B.C.Y action

**Rated impulse voltage:** 2.5 kV

**Data interface:** RESOLVBus®, SD card slot

**VBus® current supply:** 35 mA

**Functions:** 7 integrated calorimeters and control of weather-compensated heating circuits. Adjustable system parameters and add-on options (menu-driven), balance and diagnostics functions, function control according to VDI 2169

**Housing:** plastic, PC-ABS and PMMA

**Mounting:** wall mounting, also suitable for mounting into patch panels

**Indication / Display:** full graphic display

**Operation:** 7 buttons

**Protection type:** IP 20 / DIN EN 60529

**Protection class:** I

**Ambient temperature:** 0 ... 40 °C

**Degree of pollution:** 2

**Dimensions:** 253 × 200 × 47 mm

## 1.1 Optional functions

Solar	Arrangement	Heating
Bypass	Parallel relay	Thermal disinfection
CS bypass	Mixer	DHW heating
External heat exchanger	Zone loading	DHW preheating
Tube collector	Error relay	
Target temperature	Heat exchange	
Antifreeze	Solid fuel boiler	
Backup heating suppression	Circulation	
Parallel relay	Return preheating	
Cooling mode	Function block	
Drainback	Irradiation switch	
Twin pump	Return mixing function	
Heat dump		
Flow rate monitoring		
Pressure monitoring		

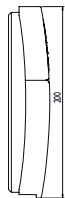
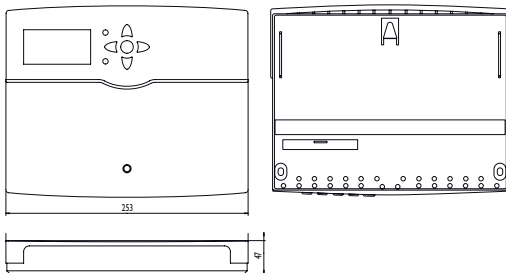

## 2 Installation

### 2.1 Mounting

#### WARNING! Electric shock!



Upon opening the housing, live parts are exposed!

→ **Always disconnect the device from power supply before opening the housing!**



#### Note

Strong electromagnetic fields can impair the function of the device.

→ Make sure the device as well as the system are not exposed to strong electromagnetic fields.

The unit must only be located in dry interior rooms.

The controller must additionally be supplied from a double pole switch with contact gap of at least 3 mm.

Please pay attention to separate routing of sensor cables and mains cables.

In order to mount the device to the wall, carry out the following steps:

- Unscrew the crosshead screw from the cover and remove it along with the cover from the housing.
- Mark the upper fastening point on the wall. Drill and fasten the enclosed wall plug and screw leaving the head protruding.
- Hang the housing from the upper fastening point and mark the lower fastening points (centres 233 mm).
- Insert lower wall plugs.
- Fasten the housing to the wall with the lower fastening screw and tighten.
- Carry out the electrical wiring in accordance with the terminal allocation (see page 7).
- Put the cover on the housing.
- Attach with the crosshead screw.

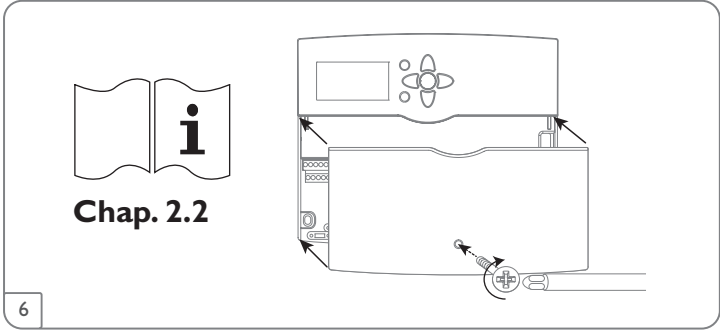
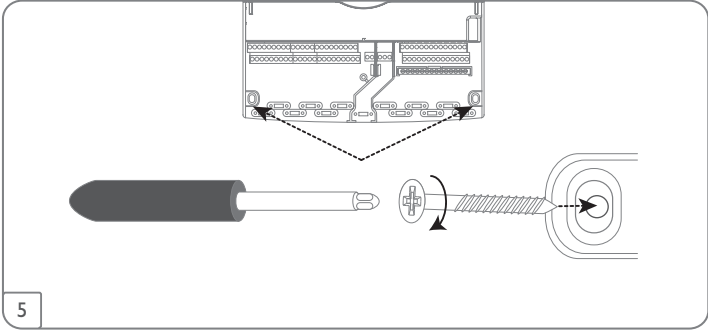
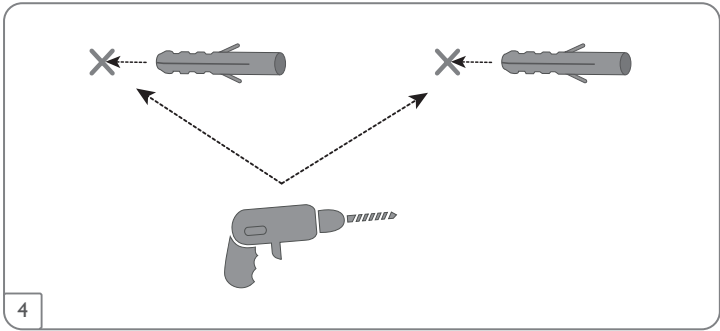
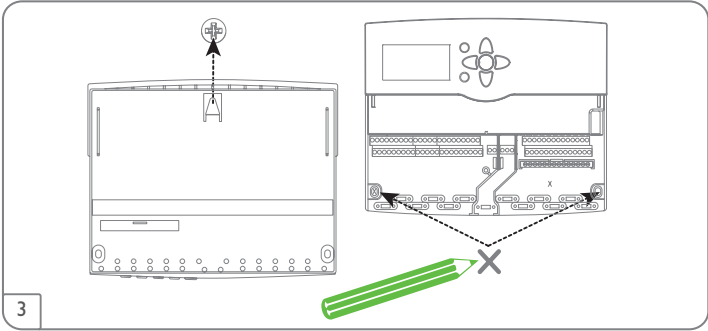
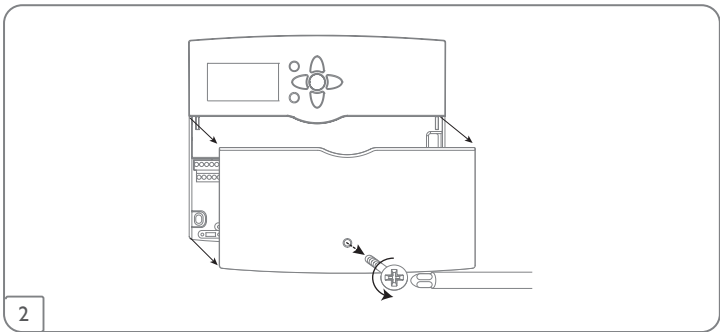
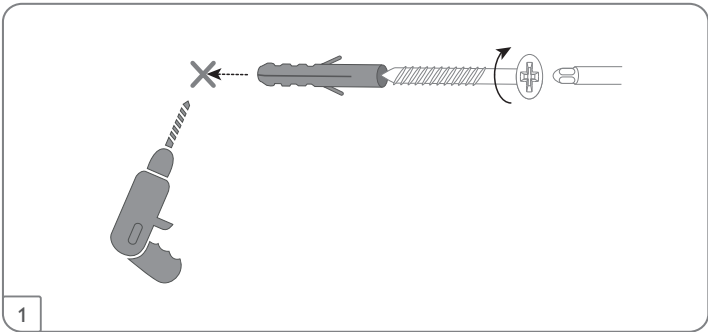

## 2.2 Electrical connection

### WARNING!

#### Electric shock!



Upon opening the housing, live parts are exposed!

→ Always disconnect the device from power supply before opening the housing!

### ATTENTION!

#### ESD damage!



Electrostatic discharge can lead to damage to electronic components!

→ Take care to discharge properly before touching the inside of the device! To do so, touch a grounded surface such as a radiator or tap!



#### Note

Connecting the device to the power supply must always be the last step of the installation!



#### Note

The pump speed must be set to 100% when auxiliary relays or valves are connected.



#### Note

It must be possible to disconnect the device from the mains at any time.

- Install the mains plug such that it is accessible at any time.
- If this is not possible, install a switch that can be accessed.

### Do not use the device if it is visibly damaged!

The controller is equipped with 14 relays in total to which loads such as pumps, valves, etc. can be connected:

Relays 1 ... 13 are semiconductor relays, designed for pump speed control:

Conductor R1 ... R13

Neutral conductor N (common terminal block)

Protective earth conductor  $\oplus$  (common terminal block)

Relay 14 is a potential-free relay:

R14-A = normally open contact

R14-M = centre contact

R14-R = normally closed contact

Depending on the product version, mains cables and sensor cables are already connected to the device. If that is not the case, please proceed as follows:

The **temperature sensors** (S1 to S12) have to be connected to the terminals S1 to S12 and GND (either polarity).

The **V40** flowmeters can be connected to the terminals S13/IMP1 to S15/IMP3 and GND (either polarity).

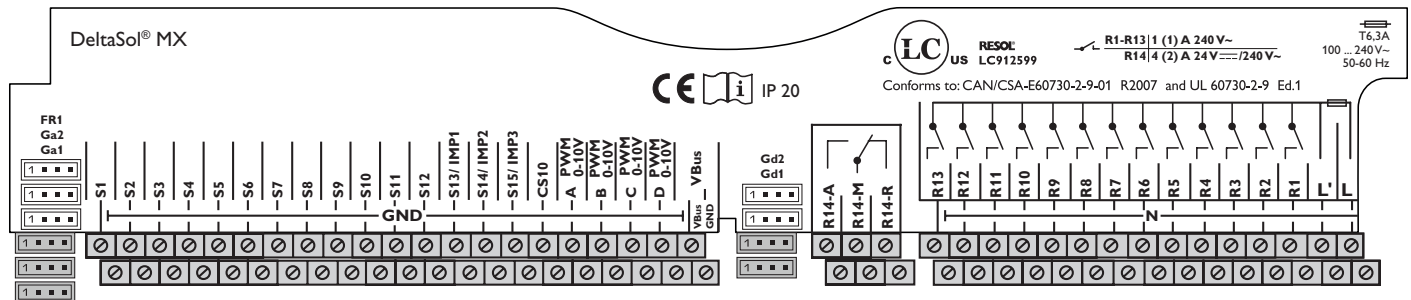

Connect the irradiation sensor **CS10** to the terminals CS10 and GND with correct polarity. To do so, connect the cable marked GND to the GND common terminal block, the cable marked CS to the terminal marked CS10.

The terminals marked **PWM/0-10V** are control outputs for high-efficiency pumps.



#### Note

When Grundfos Direct Sensors™ are used, connect the sensor ground common terminal block to PE.

Connect the **analogue Grundfos Direct Sensors™** to the Ga1 and Ga2 inputs. Connect the **digital Grundfos Direct Sensors™** to the Gd1 and Gd2 inputs.

Connect the **FlowRotor** to the FR1 input. (The FlowRotor is not available in the RESOL portfolio)

The controller is supplied with power via a mains cable. The power supply of the device must be 100... 240 V~ (50... 60 Hz).

Connect the **mains cable** to the following terminals:

Neutral conductor N

Conductor L

#### WARNING! Electric shock!



L' is a fused contact permanently carrying voltage.

→ **Always disconnect the device from power supply before opening the housing!**

Conductor L' (L' is not connected with the mains cable. L' is a fused contact permanently carrying voltage.)

Protective earth conductor ⊕ (common terminal block)



#### Note

For more details about the commissioning procedure see page 9.

## 2.3 Data communication/Bus

The controller is equipped with the RESOL VBus® for data transfer and energy supply to external modules. The connection is to be carried out at the terminals marked **VBus** (any polarity).

One or more RESOL VBus® modules can be connected via this data bus, such as:

- RESOL DL2/DL3 Datalogger
- RESOL KM2 Communication module

Furthermore, the controller can be connected to a PC or integrated into a network via the RESOL VBus®/USB or VBus® /LAN interface adapter (not included). Different solutions for visualisation and remote parameterisation are available on the website [www.resol.com](http://www.resol.com). On the website, firmware updates are also available.



#### Note

During remote parameterisation, the  symbol will be displayed, the controller will not carry out any control function.



#### Note

For more information about accessories, see page 98.

## 2.4 SD card slot

The controller is equipped with an SD card slot.

With an SD card, the following functions can be carried out:

- Store measurement and balance values onto the SD card. After the transfer to a computer, the values can be opened and visualised, e. g. in a spreadsheet.
- Prepare adjustments and parameterisations on a computer and transfer them via the SD card.
- Store adjustments and parameterisations on the SD card and, if necessary, retrieve them from there.
- Download firmware updates from the Internet and install them on the controller.

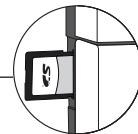

#### Note

For more information about using an SD card, see page 91.



### 3 Step-by-step parameterisation

The *DeltaSol*<sup>®</sup> MX is a controller that offers a broad variety of functions to the user. At the same time, the user has a lot of freedom in configuring them. Therefore, to set up a complex system, careful planning is required. We recommend drawing a sketch of the system first.

If planning, hydraulic construction and electrical connection have all been carried out successfully, proceed as follows:

#### 1. Running the commissioning menu

After the commissioning menu has been finished (see page 19), further adjustments can be made. The commissioning menu can be repeated any time by means of a reset (see page 90). Additional adjustments will be deleted.

For further information about the commissioning menu see page 19.

#### 2. Registering sensors

If flowmeters, flow switches, Grundfos Direct Sensors<sup>™</sup>, a FlowRotor, room control units, remote controls, switches and/or external extension modules are connected, these have to be registered in the **Inputs/Modules** menu.

For further information about the registration of modules and sensors see page 93.

#### 3. Activating solar optional functions

The basic solar system has been adjusted during commissioning. Now, up to 16 optional functions can be selected, activated and adjusted.

Relays available can be allocated to optional functions which require a relay. The controller always suggests the numerically smallest relay available.

Sensors can be allocated to more than one function.

For further information about the solar optional functions see page 50.

#### 4. Activating optional arrangement functions

Up to 16 optional functions for the non-solar part of the arrangement can be selected, activated and adjusted.

Relays available can be allocated to optional functions which require a relay. The controller always suggests the numerically smallest relay available.

Sensors can be allocated to more than one function.

For further information about the optional arrangement functions see page 64.

#### 5. Adjusting heating circuits and activating optional heating functions

If one or more heating circuits are to be controlled, heating circuits can be activated and adjusted. Internal heating circuits can only be activated if at least 3 relays are available.

For the heating part of the arrangement, up to 16 optional functions can be selected, activated and adjusted.

To heating circuits and optional functions which require one or more relays, the corresponding number of free relays can be allocated. The controller always suggests the numerically smallest relay available.

Sensors can be allocated to more than one function.

For further information about heating circuits and optional heating functions see page 75.

## 4 Operation and function

### 4.1 Buttons

The controller is operated via the 7 buttons next to the display. They have the following functions:

- Button 1 - scrolling upwards
- Button 3 - scrolling downwards
- Button 2 - increasing adjustment values
- Button 4 - reducing adjustment values
- Button 5 - confirming
- Button 6 - entering the status menu / chimney sweeper mode (system-dependent)
- Button 7 - escape button for changing into the previous menu / to the holidays menu

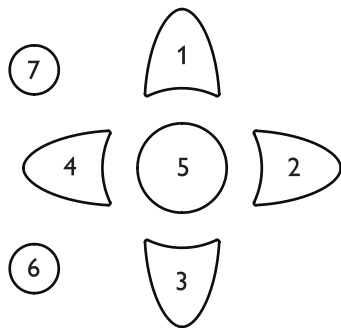

#### Operating control LED (in the directional pad)

- Green: Everything OK
- Red: Screed drying cancellation
- Red flashing: Sensor fault / initialisation / chimney sweeper function active
- Green flashing: Manual mode / screed drying active

### 4.2 Selecting menu points and adjusting values

During normal operation of the controller, the display is in the main menu. If no button is pressed for 1 min, the display illumination goes out. After 4 further minutes, the controller will display the home screen (see page 47).

Press any key to reactivate the display illumination.

- ➔ In order to scroll through a menu or to adjust a value, press either buttons 1 and 3 or buttons 2 and 4.
- ➔ To open a submenu or to confirm a value, press button 5.
- ➔ To enter the status menu, press button 6 – unconfirmed adjustments will not be saved.
- ➔ To enter the previous menu, press button 7 – unconfirmed adjustments will not be saved.

If no button has been pressed within a couple of minutes, the adjustment is cancelled and the previous value is retained.

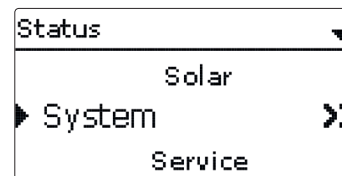

If the symbol »» is shown behind a menu item, pressing button 5 will open a new submenu.

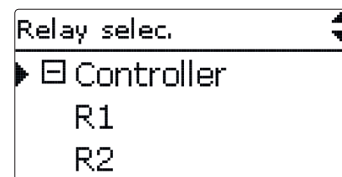

If the symbol ⊕ is shown in front of a menu item, pressing button 5 will open a new submenu. If it is already opened, a ⊞ is shown instead of the ⊕.

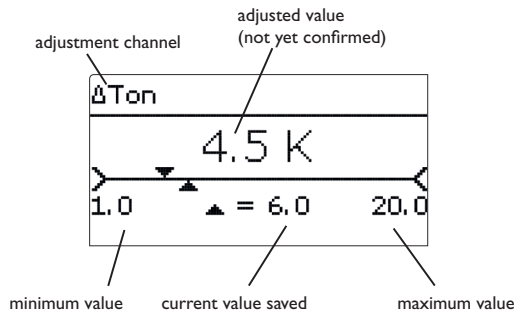

Values and adjustments can be changed in different ways:

Numeric values can be adjusted by means of a slide bar. The minimum value is indicated to the left, the maximum value to the right. The large number above the slide bar indicates the current adjustment. By pressing buttons  $\leftarrow$  or  $\rightarrow$  the upper slide bar can be moved to the left or to the right.

Only after the adjustment has been confirmed by pressing button  $\text{S}$  will the number below the slide bar indicate the new value. The new value will be saved if it is confirmed by pressing button  $\text{S}$  again.

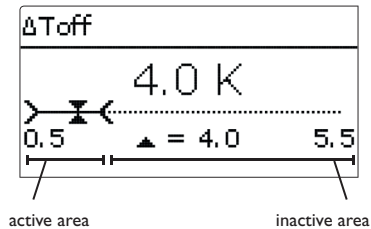

When 2 values are locked against each other, they will display a reduced adjustment range depending on the adjustment of the respective other value.

In this case, the active area of the slide bar is shortened, the inactive area is indicated as a dotted line. The indication of the minimum and maximum values will adapt to the reduction.

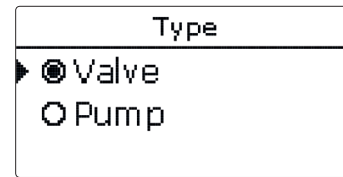

If only one item of several can be selected, they will be indicated with radio buttons. When one item has been selected, the radio button in front of it is filled.

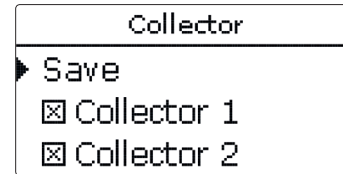

If more than one item of several can be selected, they will be indicated with checkboxes. When an item has been selected, an x appears inside the checkbox.

### 4.3 Adjusting the timer

When the **Timer** option is activated, a timer is indicated in which time frames for the function can be adjusted.

In the **Day selection** channel, the days of the week are available individually and as frequently selected combinations.

If more than one day or combination is selected, they will be merged into one combination for the following steps.

The last menu item after the list of days is **Continue**. If **Continue** is selected, the timer menu opens, in which the time frames can be adjusted.

▶ Day selection  
Reset  
back

Day selection  
 Mon-Sun  
 Mon-Fri  
 Sat-Sun  
 Mon  
 Tue  
 Wed  
 Thu  
 Fri  
 Sat  
 Sun  
▶ Continue

➔ In order to save the time frame, select **Save** and confirm the security enquiry with **Yes**.

Stop  
08:30

Mon, Wed, Sun  
Start 06:00  
Stop 08:30  
▶ Save

Save?  
Yes

#### Adding a time frame:

In order to add a time frame, proceed as follows:

➔ Select **New time frame**.

Mon, Wed, Sun  
00 06 12 18  
▶ New time frame  
Copy from

➔ In order to add another time frame, repeat the previous steps.

6 time frames can be adjusted per day or combination.

Mon, Wed, Sun  
00 06 12 18  
▶ New time frame  
Copy from

Mon, Wed, Sun  
▶ Start --:--  
Stop --:--  
back

Mon, Wed, Sun  
00 06 12 18  
▶ New time frame  
Copy from

➔ Adjust **Start** and **Stop** for the desired time frame. The time frames can be adjusted in steps of 5 min.

Start  
06:00

➔ Press the left button (↩) in order to get back to the day selection.

Day selection  
▶ Mon, Wed, Sun  
Reset

### Copying a time frame:

In order to copy time frames already adjusted into another day/another combination, proceed as follows:

- ➔ Choose the day/the combination into which the time frames are to be copied and select **Copy from**.

A selection of days and/or combinations with time frames will appear:

- ➔ Select the day or combination from which the time frames are to be copied.

All time frames adjusted for the selected day or combination will be copied.

If the time frames copied are not changed, the day or combination will be added to the combination from which the time frames have been copied.

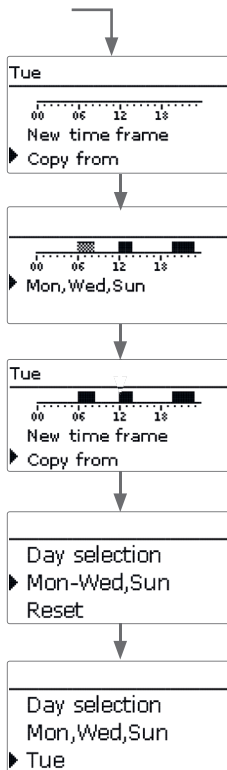

### Changing a time frame:

In order to change a time frame, proceed as follows:

- ➔ Select the time frame to be changed.
- ➔ Make the desired change.

- ➔ In order to save the time frame, select **Save** and confirm the security enquiry with **Yes**.

### Removing a time frame:

In order to delete a time frame, proceed as follows:

- ➔ Select the time frame that is to be deleted.
- ➔ Select **Delete** and confirm the security enquiry with **Yes**.

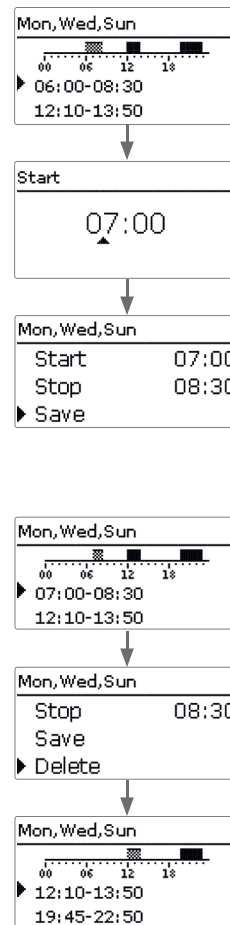

### Resetting the timer:

In order to reset time frames adjusted for a certain day or combination, proceed as follows

→ Select the desired day or combination.

Day selection
▶ Mon,Wed,Sun
Tue

Tue

New time frame
▶ Copy from

Reset
Reset?      Yes

→ Select **Reset** and confirm the security enquiry with **Yes**.

The selected day or combination will disappear from the list, all its time frames will be deleted.

Day selection
Tue
Reset

In order to reset the whole timer, proceed as follows:

→ Select **Reset** and confirm the security enquiry with **Yes**.

Mon,Wed,Sun
Tue
▶ Reset

Reset
Reset?      Yes

All adjustments made for the timer are deleted.

Day selection
▶ Reset
back

### 4.4 Adjusting optional functions

Add new function
▶ Bypass
CS bypass
Ext. HX

In the **Optional functions** menus, optional functions can be selected and adjusted. By selecting **Add new function**, different pre-programmed functions can be selected.

The kind and number of optional functions offered depends on the previous adjustments.

Bypass
▶ Collector      1-3
Output            R8
Type              Pump

When a function is selected, a submenu will open in which all adjustments required can be made.

In this submenu, an output and, if necessary, certain system components can be allocated to the function.

If an output can be allocated to the function, the output selection menu **Output** will open (see page 16).

Bypass pump 1
▶ <input checked="" type="checkbox"/> Relay
Relay            R8
<input type="checkbox"/> PWM/0-10 V

When a function has been adjusted and saved, it will appear in the **Optional functions** menu above the menu item **Add new function**.

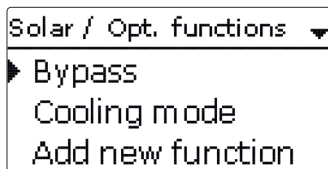

This allows an easy overview of functions already saved.

An overview about which sensor has been allocated to which component and which relay has been allocated to which function is given in the **Status** menu.

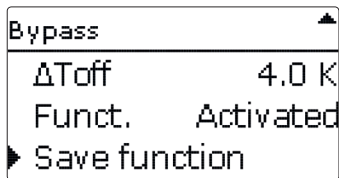

At the end of each optional function submenu, the menu items **Function** and **Save function** are available. In order to save a function, select Save function and confirm the security enquiry by selecting Yes.

In functions already saved, the menu item Delete function will appear instead.

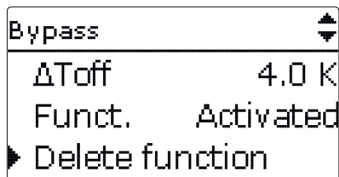

In order to delete a function already saved, select **Delete function** and confirm the security enquiry by selecting Yes. The function will become available under **Add new function** again. The corresponding outputs will be available again.

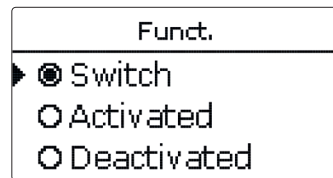

With the menu item **Function**, an optional function already saved can be temporarily deactivated or re-activated respectively. In this case, all adjustments will remain stored, the allocated outputs will remain occupied and cannot be allocated to another function. The allocated sensor will be monitored for faults.

By selecting **Switch**, the function can be activated or deactivated respectively by means of an external potential-free switch.

The selection is only available if a sensor input has previously been set to **Switch** in the **Inputs/Modules** menu.

If **Switch** is selected, the channel **Sensor** will appear. In this channel, the sensor input to which the switch is to be connected can be allocated to the function.

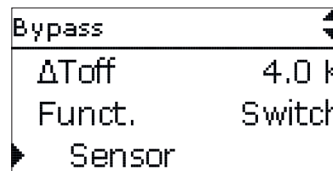

## 4.5 Output selection submenu

The **Output selection** submenu is available in almost all optional functions. Therefore, it will not be explained in the individual function descriptions.

In this submenu, relays and/or signal outputs can be allocated to the function selected. All adjustments required for the outputs can be made in this menu.

All controller and module (if connected) outputs available will be displayed. If - is selected, the function will run normally in the software but will not operate an output. Relay and signal outputs can be activated separately. Depending on the adjustments made, the following results are possible:

Adjustment channel	Description	Adjustment range/selection	Factory setting
Relay	Relay option	Yes, No	No
Relay	Relay selection	system dependent	system dependent
PWM/0-10V	PWM/0-10V option	Yes, No	No
Output	Signal output selection	system dependent	system dependent
Signal	Signal type	PWM, 0-10V	PWM
Profile	Characteristic curve	Solar, Heating	Solar
Speed	Speed control	Yes, No	system dependent
Min.	Minimum speed	20 ... 100%	20%
Max.	Maximum speed	20 ... 100%	100%
Adapter	Adapter option	Yes, No	No
Inverted	Inverted switching option	Yes, No	No
Blocking protection	Blocking protection option	Yes, No	No
Manual mode	Operating mode	Max, Auto, Min, Off	Auto

1 relay and/or 1 0-10V output can be allocated to each output selection.

### Settings

Relay option	PWM/0-10V option	Speed control	Adapter option
Yes	Yes	Yes	Yes
Yes	No	Yes	No
Yes	No	Yes	Yes
Yes	No	No	irrelevant*
Yes	Yes	Yes	No
Yes	Yes	Yes	Yes
Yes	Yes	No	irrelevant*
No	Yes	Yes	irrelevant*
No	Yes	No	irrelevant*

### Result

Behaviour of the relay output	Behaviour of the signal output	Behaviour of the adapter
→ On/Off	Modulating	Modulating
→ Burst control	-	Modulating
→ On/Off	-	Modulating
→ On/Off	-	0%/100%
→ On/Off	Modulating	0%/100%
→ On/Off	Modulating	Modulating
→ On/Off	0%/100%	0%/100%
→ -	Modulating	-
→ -	0%/100%	-

\* If the Relay option and/or speed control is deactivated, the adjustment in the adapter option will have no effect.



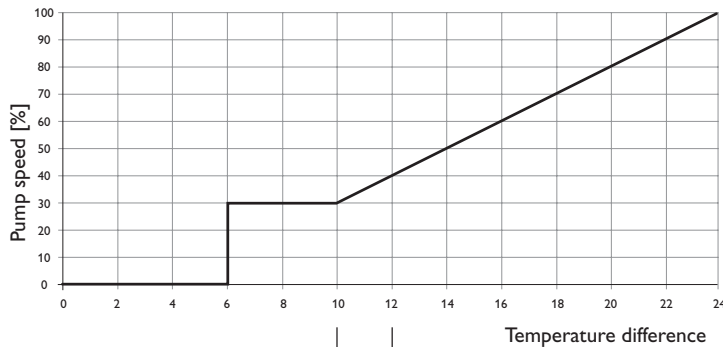

Detail

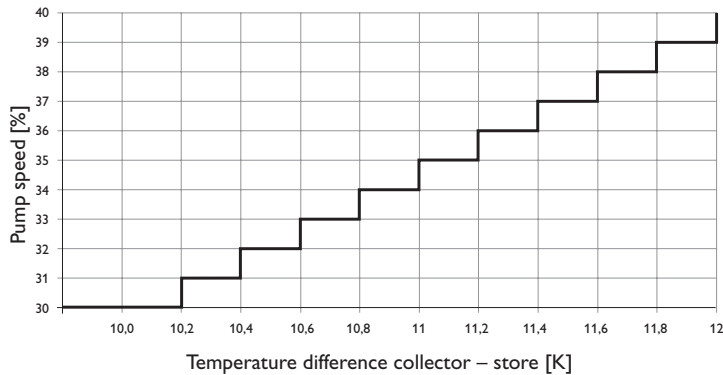

## Speed control

In the **Speed** adjustment channel, the speed control for the output can be activated or deactivated respectively. If **Yes** is selected, the channels **Min.**, **Max.** and **Adapter** will appear.

In the **Min.** adjustment channel, a relative minimum speed for a pump connected can be allocated to the output.

In the **Max.** adjustment channel, a relative maximum speed for a pump connected can be allocated to the output.

If the speed control signal is generated via a VBus®/PWM interface adapter, the **Adapter** option has to be activated. If **Yes** is selected, the relay will switch on or off (no burst control). Speed information will be transmitted via the VBus®.

For functions controlling loads which are not speed controlled, the speed control will not be shown on the display (e. g. the bypass type, mixer).

If the temperature difference reaches or exceeds the Switch-on temperature difference, the pump switches on at 100% speed for 10 s. Then, the speed is reduced to the Minimum pump speed value. If the temperature difference exceeds the adjusted Set value by 1/10 of the rise value, the pump speed increases by one step (1%). The response of the controller can be adapted via the parameter Rise. Each time the difference increases by 1/10 of the adjustable Rise value, the pump speed increases by one step until the Maximum pump speed of 100% is reached. If the temperature difference decreases by 1/10 of the adjustable Rise value, pump speed will be decreased by one step.

## Relay option

If the **Relay** option is activated, a relay can be allocated to the output selection.

## 0-10 V option

If the **0-10 V** option is activated, a 0-10 V output can be allocated to the output selection.

In the **Signal** channel, a selection between a PWM or a 0-10 V signal can be made. In the **Profile** channel, characteristic curves for solar and heating pumps can be selected.

### Signal characteristic: PWM; Profile: Solar

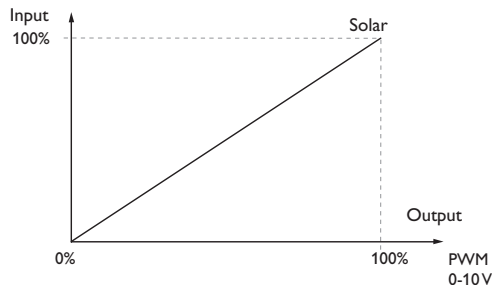

### Signal characteristic: PWM; Profile: Heating

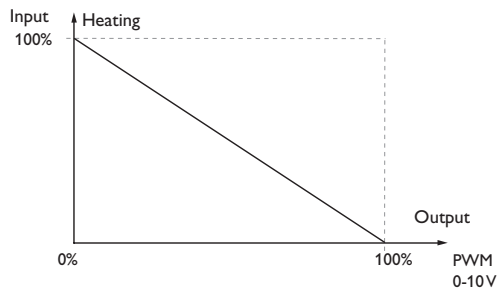

## Blocking protection

In order to protect the pumps against blocking after standstill, the controller is equipped with a blocking protection option. This option can be activated in the output selection submenu. The **Blocking protection** option can be adjusted in the **Basic setting/Blocking protection** menu (see page 90).

## Manual mode

In the **Manual mode** adjustment channel, the operating mode of the output can be selected. The following options are available:

Off = Output is switched off (manual mode)

Min = Output active with minimum speed (manual mode)

Max = Output active at 100% speed (manual mode)

Auto = Output is in automatic mode



### Note

After service and maintenance work, the operating mode must be set back to **Auto**. Normal operation is not possible in manual mode.

## 5 Commissioning

When the hydraulic system is filled and ready for operation, connect the controller to the mains.

The controller runs an initialisation phase in which the directional pad flashes red. When the controller is commissioned or when it is reset, it will run a commissioning menu after the initialisation phase. The commissioning menu leads the user through the most important adjustment channels needed for operating the system.

### Commissioning menu

The commissioning menu consists of the channels described in the following. In order to make an adjustment, press button (5). Adjust the value by pressing buttons (4) and (2), then push button (5) to confirm. The next channel will appear in the display.

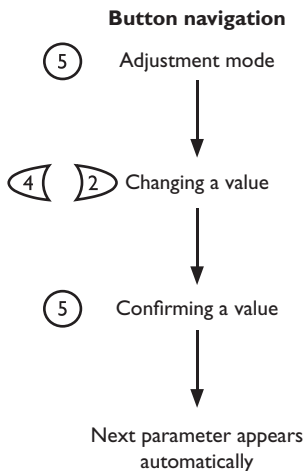

#### 1. Language:

→ Adjust the desired menu language.

Language
Deutsch
▶ English
Francais

#### 2. Units:

→ Adjust the desired unit system.

Units
<input type="radio"/> °F / gal / MBTU
▶ <input checked="" type="radio"/> °C / Liter / kWh

#### 3. Daylight savings time adjustment:

→ Activate or deactivate the automatic daylight savings time adjustment.

Auto DST
▶ <input checked="" type="radio"/> Yes
<input type="radio"/> No

#### 4. Time:

→ Adjust the clock time. First of all adjust the hours, then the minutes.

Time
12:26

#### 5. Date:

→ Adjust the date. First of all adjust the year, then the month and then the day.

Date
?? ?? 2016

#### 6. Selection: System or Scheme

→ Choose whether the controller is to be configured with a scheme number or with a system and a variant.

System or scheme
<input type="radio"/> Scheme
▶ <input checked="" type="radio"/> System

### 7a. Scheme (if 6. = Scheme):

- ➔ Enter the scheme number of the desired system.

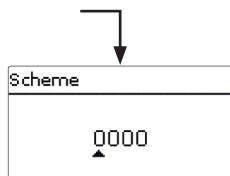

### 7b. Selection of the solar system (if 6. = System):

- ➔ Adjust the desired solar system (number of collectors and stores, hydraulic variants).



### 8. Completing the commissioning menu:

After the system has been selected or the scheme number has been entered, a security enquiry appears. If the security enquiry is confirmed, the adjustments will be saved.

- ➔ In order to confirm the security enquiry, press button 5.
- ➔ In order to reenter the commissioning menu channels, press button 7. If the security enquiry has been confirmed, the controller will be ready for operation and should enable an optimum system operation.

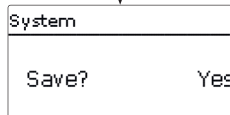

#### Note

The adjustments carried out during commissioning can be changed anytime in the corresponding adjustment channel. Additional functions and options can also be activated or deactivated (see page 44).

**Set the code to the customer code before handing over the controller to the customer (see page 93).**

## 5.1 Basic systems

The controller is pre-programmed for 13 basic systems. The selection depends on the number of heat sources (collector fields) and heat sinks (stores, pool). Factory setting is system 1.1.1.

The selection of the basic solar system is one of the most important adjustments and is thus requested already in the commissioning menu.

First, the number of collector fields and stores will have to be adjusted, then the hydraulic variant.



#### Note

A solar system with store loading in layers is implemented as a 2-store system (store top = store 1; store base = store 2).

The system selected is visualised by the corresponding number of store and collector symbols. The exemplary figure shows system 2.3.x with 2 collector fields and 3 stores.

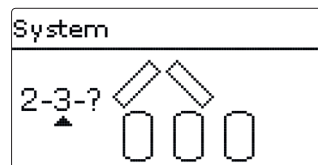

The hydraulic variant refers to the different actuators that are to be controlled. They are visualised on the display by means of symbols, when the variant is selected. The upper symbol indicates the actuator belonging to the collector fields, the lower one the actuators belonging to the stores.

The exemplary figure shows the display indicated when system 2.3.2 has been selected.

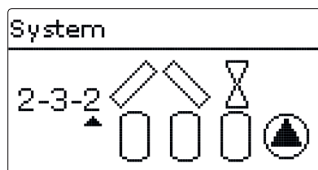

In this case, each collector field has a 2-port valve, the stores are loaded by means of pump logic.

The controller allocates corresponding relay and sensor settings for each basic system. The allocations of all combinations are shown in chap. 5.2.

System 1.1.1

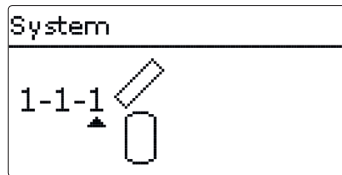

Sensors		Relays; PWM/0-10	
Collector 1	S1	Solar pump	R1;A
Store base	S2		

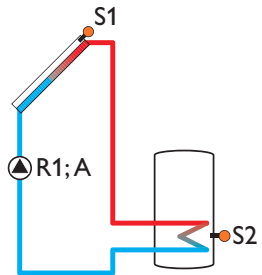

System 1.2.1

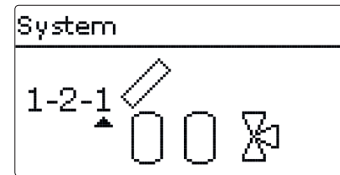

Sensors		Relays; PWM/0-10	
Collector	S1	Solar pump	R1;A
Store 1 base	S2	3-PV store 2	R2
Store 2 base	S4		

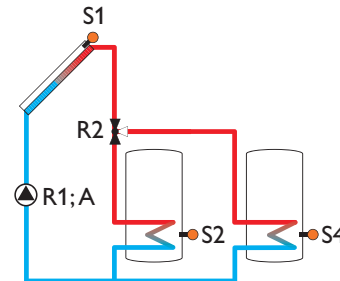

**System 1.2.2**

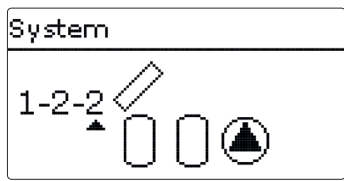

**Sensors**

Collector	S1
Store 1 base	S2
Store 2 base	S4

**Relays; PWM/0-10**

Solar pump store 1	R1; A
Solar pump store 2	R2; B

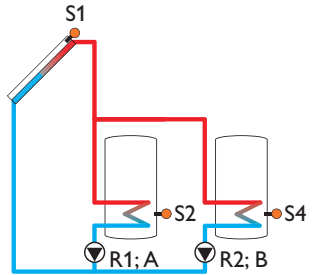

**System 1.2.3**

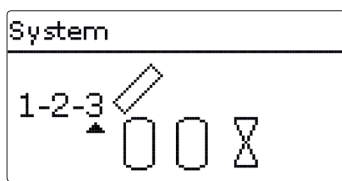

**Sensors**

Collector	S1
Store 1 base	S2
Store 2 base	S4

**Relays; PWM/0-10**

Solar pump	R1; A
2-PV store 1	R2
2-PV store 2	R3

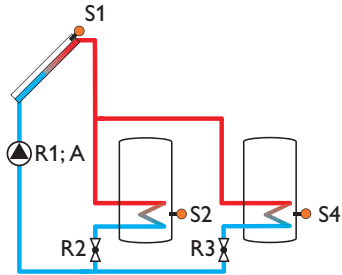

### System 1.3.1

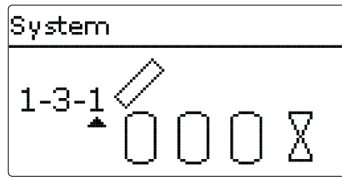

Sensors		Relays; PWM/0-10	
Collector 1	S1	Solar pump	R1;A
Store 1 base	S2	2-PV store 1	R2
Store 2 base	S4	2-PV store 2	R3
Store 3 base	S5	2-PV store 3	R4

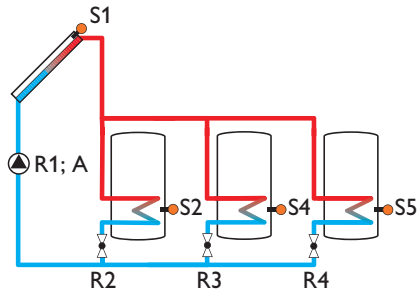

### System 1.3.2

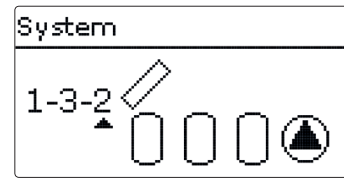

Sensors		Relays; PWM/0-10	
Collector 1	S1	Solar pump store 1	R1;A
Store 1 base	S2	Solar pump store 2	R2;B
Store 2 base	S4	Solar pump store 3	R3;C
Store 3 base	S5		

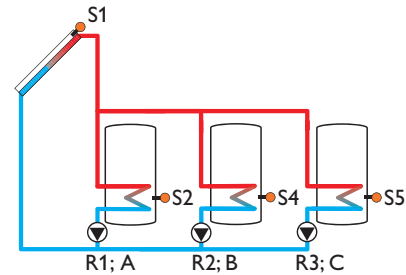

**System 1.3.3**

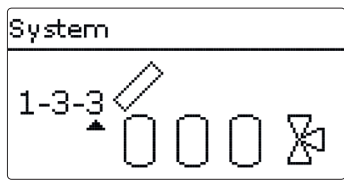

Sensors		Relays; PWM/0-10	
Collector 1	S1	Solar pump	R1;A
Store 1 base	S2	3-PV store 1	R2
Store 2 base	S4	3-PV store 2	R3
Store 3 base	S5		

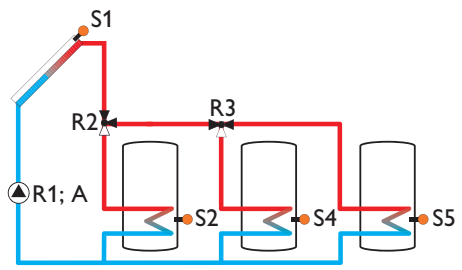

**System 1.4.1**

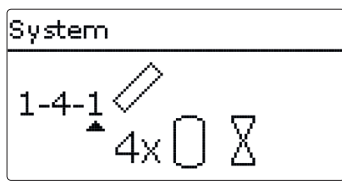

Sensors		Relays; PWM/0-10	
Collector 1	S1	Solar pump	R1;A
Store 1 base	S2	2-PV store 1	R2
Store 2 base	S4	2-PV store 2	R3
Store 3 base	S5	2-PV store 3	R4
Store 4 base	S6	2-PV store 4	R5

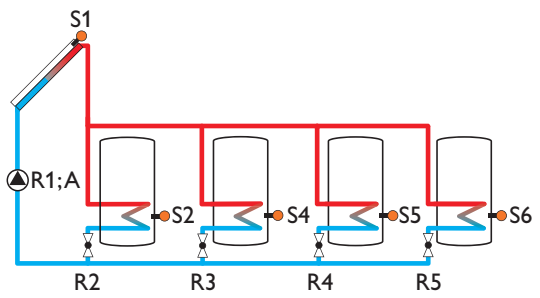



### System 1.4.2

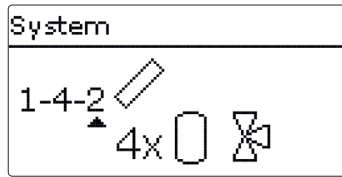

Sensors		Relays; PWM/0-10	
Collector 1	S1	Solar pump	R1; A
Store 1 base	S2	3-PV store 1	R2
Store 2 base	S4	3-PV store 2	R3
Store 3 base	S5	3-PV store 3	R4
Store 4 base	S6		

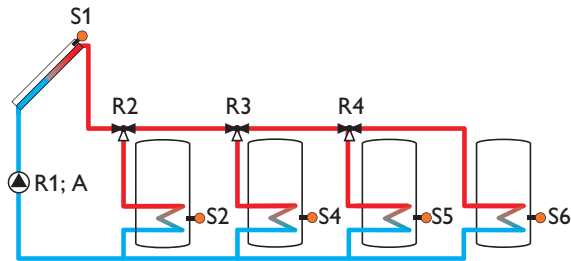

### System 1.4.3

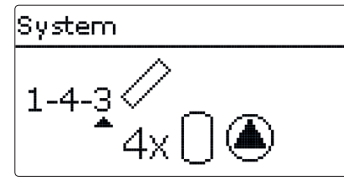

Sensors		Relays; PWM/0-10	
Collector 1	S1	Solar pump store 1	R1; A
Store 1 base	S2	Solar pump store 2	R2; B
Store 2 base	S4	Solar pump store 3	R3; C
Store 3 base	S5	Solar pump store 4	R4; D
Store 4 base	S6		

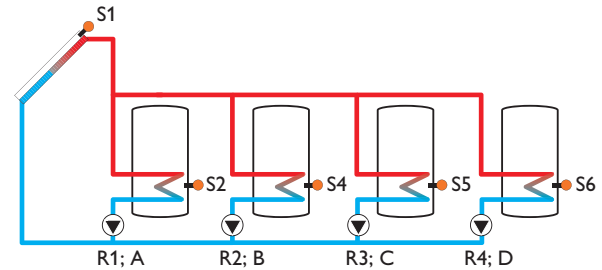

## System 1.5.1

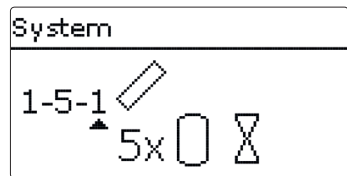

### Sensors

Collector 1	S1
Store 1 base	S2
Store 2 base	S4
Store 3 base	S5
Store 4 base	S6
Store 5 base	S7

### Relays; PWM/0-10

Solar pump	R1;A
2-PV store 1	R2
2-PV store 2	R3
2-PV store 3	R4
2-PV store 4	R5
2-PV store 5	R6

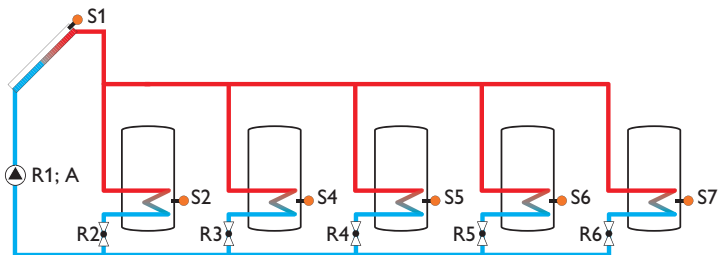

## System 1.5.2

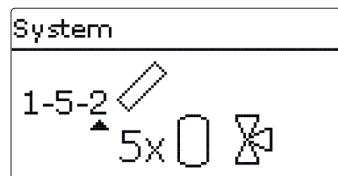

### Sensors

Collector 1	S1
Store 1 base	S2
Store 2 base	S4
Store 3 base	S5
Store 4 base	S6
Store 5 base	S7

### Relays; PWM/0-10

Solar pump	R1;A
3-PV store 1	R2
3-PV store 2	R3
3-PV store 3	R4
3-PV store 4	R5
3-PV store 5	R6

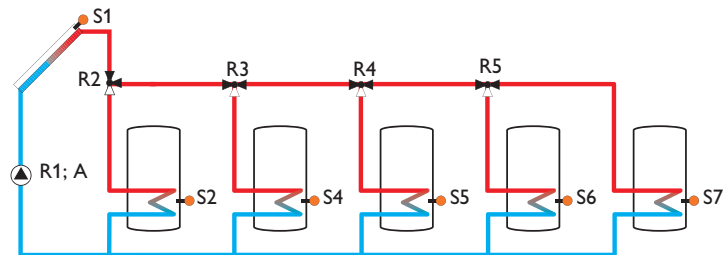

### System 1.5.3

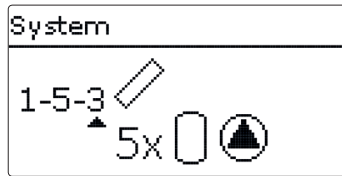

Sensors		Relays; PWM/0-10	
Collector 1	S1	Solar pump store 1	R1; A
Store 1 base	S2	Solar pump store 2	R2; B
Store 2 base	S4	Solar pump store 3	R3; C
Store 3 base	S5	Solar pump store 4	R4; D
Store 4 base	S6	Solar pump store 5	R5; on/off
Store 5 base	S7		

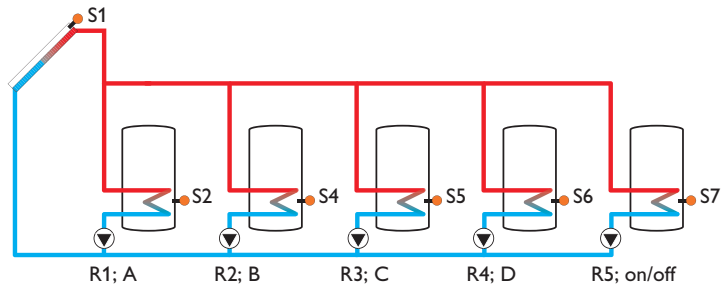

### System 2.1.1

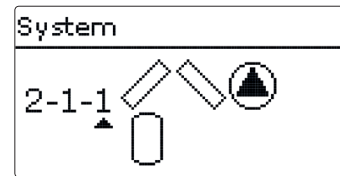

Sensors		Relays; PWM/0-10	
Collector 1	S1	Pump collector 1	R1; A
Store base	S2	Pump collector 2	R2; B
Collector 2	S6		

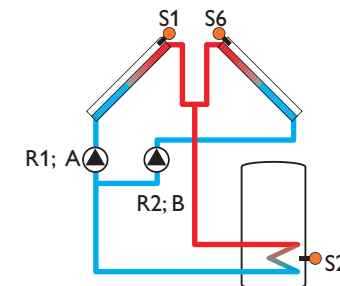

**System 2.1.2**

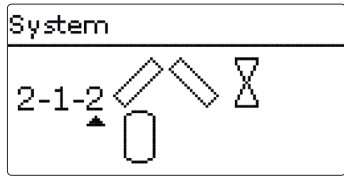

Sensors		Relays; PWM/0-10	
Collector 1	S1	2-PV collector 1	R1
Store base	S2	2-PV collector 2	R2
Collector 2	S6	Solar pump	R3;A

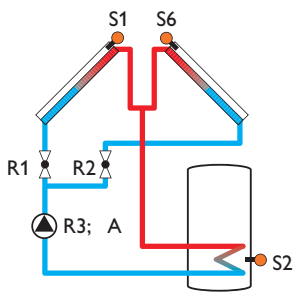

**System 2.2.1**

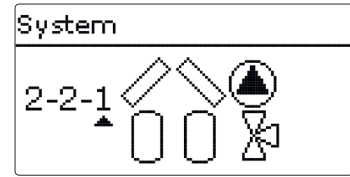

Sensors		Relays; PWM/0-10	
Collector 1	S1	Pump collector 1	R1;A
Store 1 base	S2	Pump collector 2	R2; B
Store 2 base	S4	3-PV store 2	R3
Collector 2	S6		

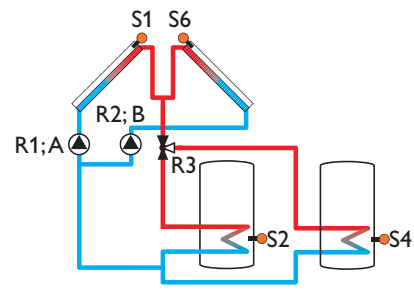

### System 2.2.2

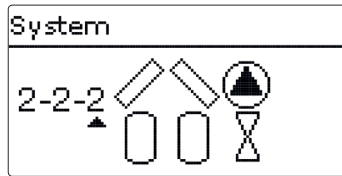

Sensors		Relays; PWM/0-10	
Collector 1	S1	Pump collector 1	R1;A
Store 1 base	S2	Pump collector 2	R2;B
Store 2 base	S4	2-PV store 1	R3
Collector 2	S6	2-PV store 2	R4

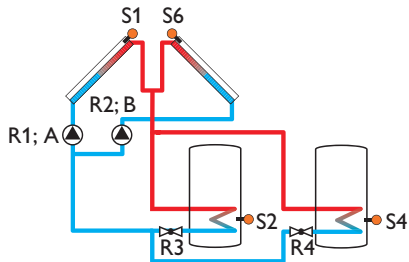

### System 2.2.3

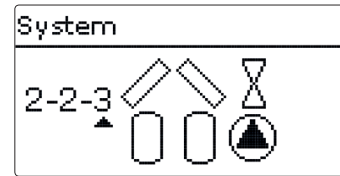

Sensors		Relays; PWM/0-10	
Collector 1	S1	2-PV collector 1	R1
Store 1 base	S2	2-PV collector 2	R2
Store 2 base	S4	Solar pump store 1	R3;A
Collector 2	S6	Solar pump store 2	R4;B

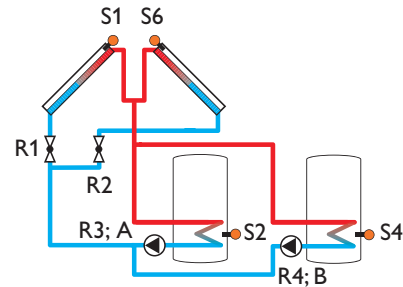

System 2.2.4

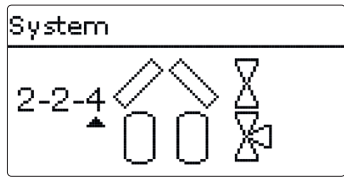

Sensors		Relays; PWM/0-10	
Collector 1	S1	2-PV collector 1	R1
Store 1 base	S2	2-PV collector 2	R2
Store 2 base	S4	Solar pump	R3;A
Collector 2	S6	3-PV store 2	R4

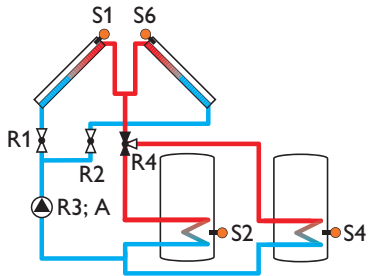

System 2.2.5

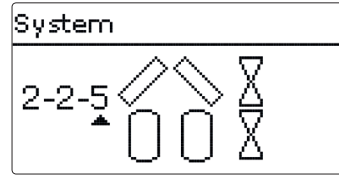

Sensors		Relays; PWM/0-10	
Collector 1	S1	2-PV collector 1	R1
Store 1 base	S2	2-PV collector 2	R2
Store 2 base	S4	Solar pump	R3;A
Collector 2	S6	2-PV store 1	R4
		2-PV store 2	R5

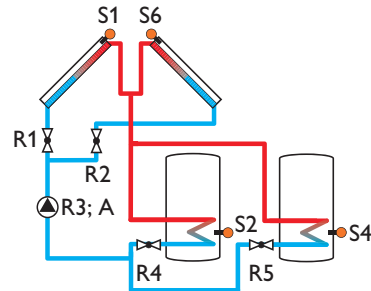

### System 2.3.1

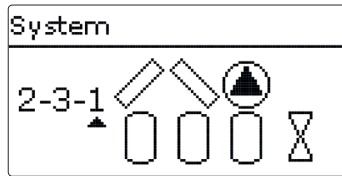

Sensors		Relays; PWM/0-10	
Collector 1	S1	Pump collector 1	R1;A
Store 1 base	S2	Pump collector 2	R2;B
Store 2 base	S4	2-PV store 1	R3
Store 3 base	S5	2-PV store 2	R4
Collector 2	S6	2-PV store 3	R5

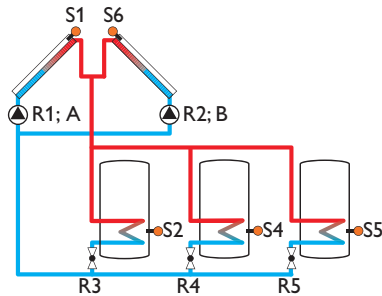

### System 2.3.2

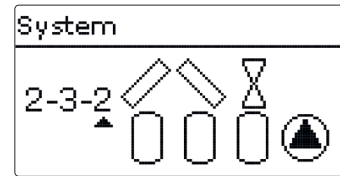

Sensors		Relays; PWM/0-10	
Collector 1	S1	Solar pump store 1	R1;A
Store 1 base	S2	Solar pump store 2	R2;B
Store 2 base	S4	Solar pump store 3	R3;C
Store 3 base	S5	2-PV collector 1	R4
Collector 2	S6	2-PV collector 2	R5

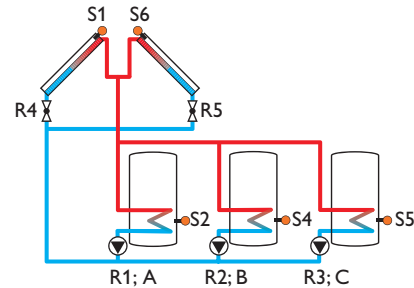

### System 2.3.3

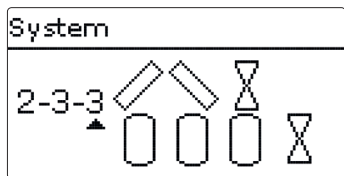

#### Sensors

Collector 1	S1
Store 1 base	S2
Store 2 base	S4
Store 3 base	S5
Collector 2	S6

#### Relays; PWM/0-10

2-PV collector 1	R1
2-PV collector 2	R2
Solar pump	R3;A
2-PV store 1	R4
2-PV store 2	R5
2-PV store 3	R6

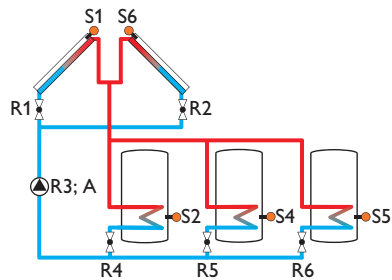

### System 2.3.4

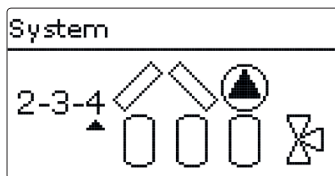

#### Sensors

Collector 1	S1
Store 1 base	S2
Store 2 base	S4
Store 3 base	S5
Collector 2	S6

#### Relays; PWM/0-10

Pump collector 1	R1;A
Pump collector 2	R2;B
3-PV store 1	R3
3-PV store 2	R4

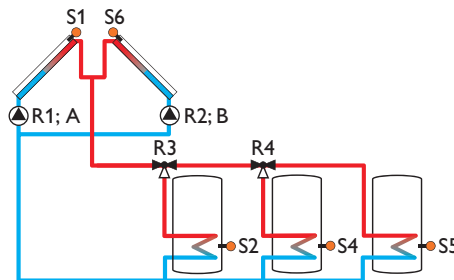



### System 2.3.5

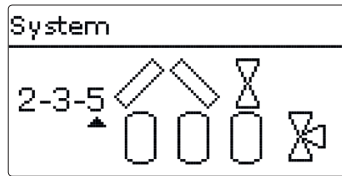

Sensors		Relays; PWM/0-10	
Collector 1	S1	2-PV collector 1	R1
Store 1 base	S2	2-PV collector 2	R2
Store 2 base	S4	Solar pump	R3;A
Store 3 base	S5	3-PV store 1	R4
Collector 2	S6	3-PV store 2	R5

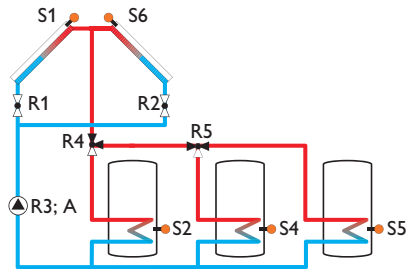

### System 2.4.1

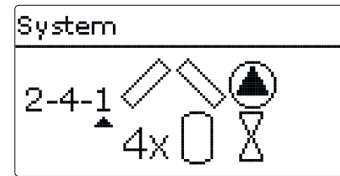

Sensors		Relays; PWM/0-10	
Collector 1	S1	Pump collector 1	R1;A
Store 1 base	S2	Pump collector 2	R2;B
Store 2 base	S4	2-PV store 1	R3
Store 3 base	S5	2-PV store 2	R4
Collector 2	S6	2-PV store 3	R5
Store 4 base	S7	2-PV store 4	R6

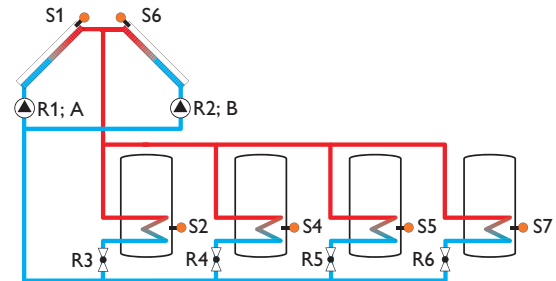

## System 2.4.2

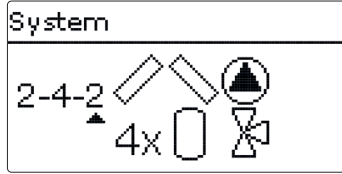

### Sensors

Collector 1	S1
Store 1 base	S2
Store 2 base	S4
Store 3 base	S5
Collector 2	S6
Store 4 base	S7

### Relays; PWM/0-10

Pump collector 1	R1; A
Pump collector 2	R2; B
3-PV store 1	R3
3-PV store 2	R4
3-PV store 3	R5

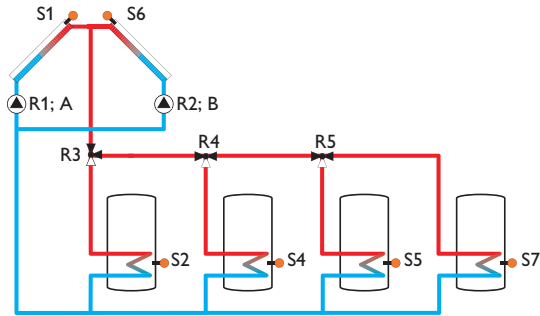

## System 2.4.3

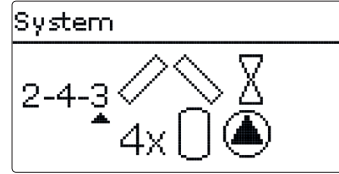

### Sensors

Collector 1	S1
Store 1 base	S2
Store 2 base	S4
Store 3 base	S5
Collector 2	S6
Store 4 base	S7

### Relays; PWM/0-10

Solar pump store 1	R1; A
Solar pump store 2	R2; B
Solar pump store 3	R3; C
Solar pump store 4	R4; D
2-PV collector 1	R5
2-PV collector 2	R6

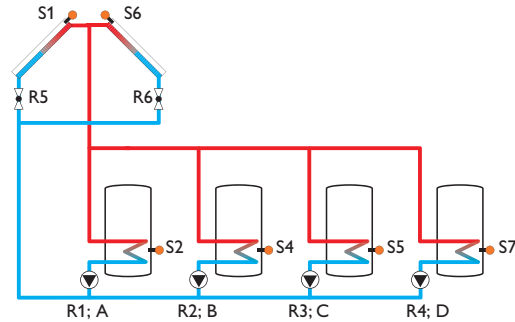

## System 2.4.4

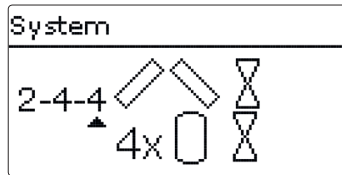

Sensors		Relays; PWM/0-10	
Collector 1	S1	2-PV collector 1	R1
Store 1 base	S2	2-PV collector 2	R2
Store 2 base	S4	Solar pump	R3;A
Store 3 base	S5	2-PV store 1	R4
Collector 2	S6	2-PV store 2	R5
Store 4 base	S7	2-PV store 3	R6
		2-PV store 4	R7

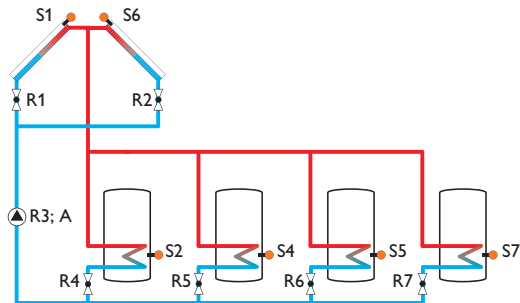

## System 2.4.5

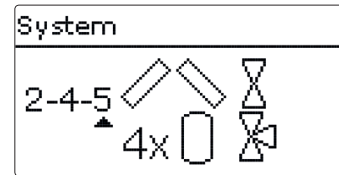

Sensors		Relays; PWM/0-10	
Collector 1	S1	2-PV collector 1	R1
Store 1 base	S2	2-PV collector 2	R2
Store 2 base	S4	Solar pump	R3;A
Store 3 base	S5	3-PV store 1	R4
Collector 2	S6	3-PV store 2	R5
Store 4 base	S7	3-PV store 3	R6

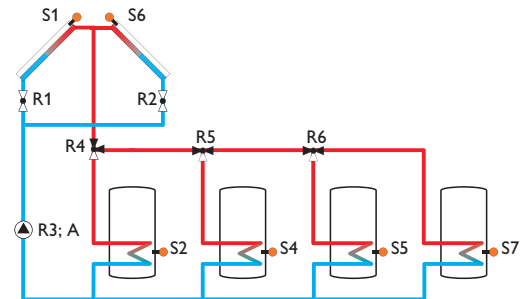

**System 3.1.1**

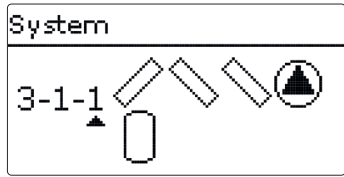

Sensors		Relays; PWM/0-10	
Collector 1	S1	Pump collector 1	R1;A
Store base	S2	Pump collector 2	R2; B
Collector 2	S6	Pump collector 3	R3; C
Collector 3	S8		

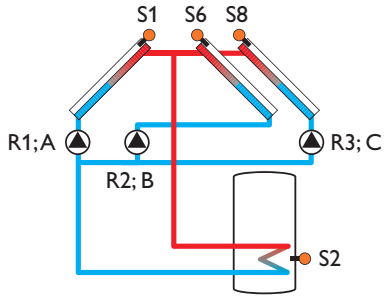

**System 3.1.2**

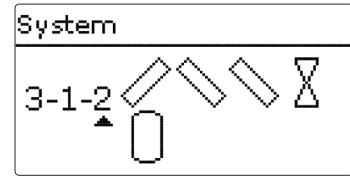

Sensors		Relays; PWM/0-10	
Collector 1	S1	2-PV collector 1	R1
Store base	S2	2-PV collector 2	R2
Collector 2	S6	Solar pump	R3;A
Collector 3	S8	2-PV collector 3	R4

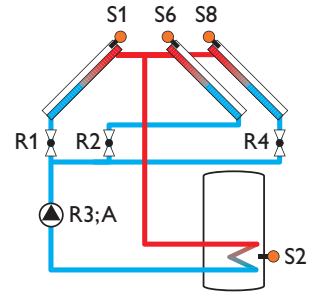

### System 3.2.1

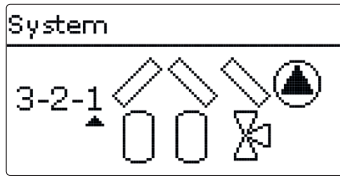

Sensors		Relays; PWM/0-10	
Collector 1	S1	Pump collector 1	R1;A
Store 1 base	S2	Pump collector 2	R2;B
Store 2 base	S4	3-PV store 2	R3
Collector 2	S6	Pump collector 3	R4;C
Collector 3	S8		

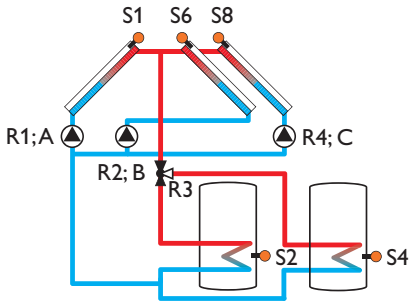

### System 3.2.2

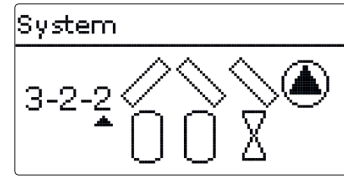

Sensors		Relays; PWM/0-10	
Collector 1	S1	Pump collector 1	R1;A
Store 1 base	S2	Pump collector 2	R2;B
Store 2 base	S4	2-PV store 1	R3
Collector 2	S6	2-PV store 2	R4
Collector 3	S8	Pump collector 3	R5;C

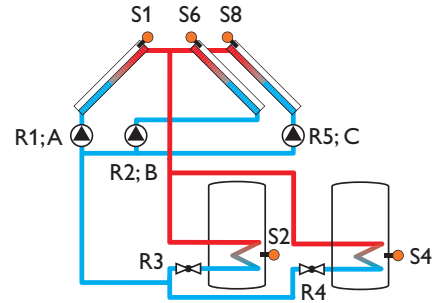

### System 3.2.3

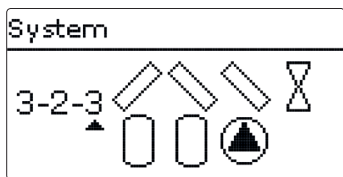

#### Sensors

Collector 1	S1
Store 1 base	S2
Store 2 base	S4
Collector 2	S6
Collector 3	S8

#### Relays; PWM/0-10

2-PV collector 1	R1
2-PV collector 2	R2
Solar pump store 1	R3;A
Solar pump store 2	R4;B
2-PV collector 3	R5

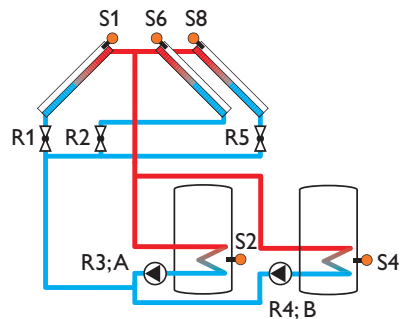

### System 3.2.4

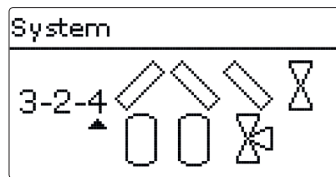

#### Sensors

Collector 1	S1
Store 1 base	S2
Store 2 base	S4
Collector 2	S6
Collector 3	S8

#### Relays; PWM/0-10

2-PV collector 1	R1
2-PV collector 2	R2
Solar pump	R3;A
3-PV store 2	R4
2-PV collector 3	R5

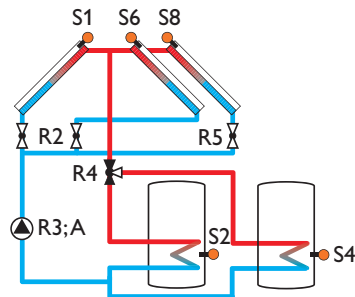

### System 3.2.5

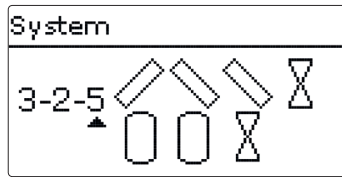

Sensors		Relays; PWM/0-10	
Collector 1	S1	2-PV collector 1	R1
Store 1 base	S2	2-PV collector 2	R2
Store 2 base	S4	Solar pump	R3;A
Collector 2	S6	2-PV store 1	R4
Collector 3	S8	2-PV store 2	R5
		2-PV collector 3	R6

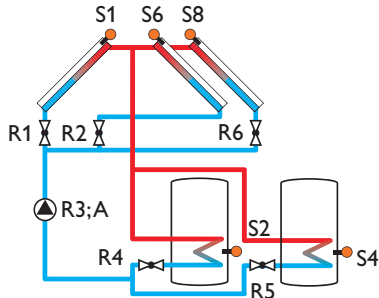

### System 3.3.1

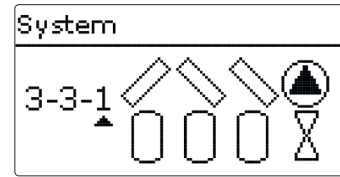

Sensors		Relays; PWM/0-10	
Collector 1	S1	Pump collector 1	R1;A
Store 1 base	S2	Pump collector 2	R2;B
Store 2 base	S4	2-PV store 1	R3
Store 3 base	S5	2-PV store 2	R4
Collector 2	S6	2-PV store 3	R5
Collector 3	S8	Pump collector 3	R6;C

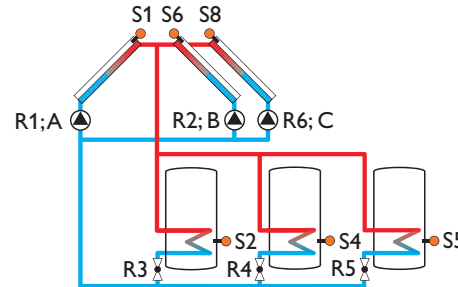

### System 3.3.2

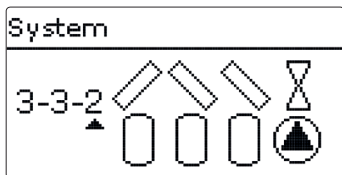

#### Sensors

Collector 1	S1
Store 1 base	S2
Store 2 base	S4
Store 3 base	S5
Collector 2	S6
Collector 3	S8

#### Relays; PWM/0-10

Solar pump store 1	R1;A
Solar pump store 2	R2;B
Solar pump store 3	R3;C
2-PV collector 1	R4
2-PV collector 2	R5
2-PV collector 3	R6

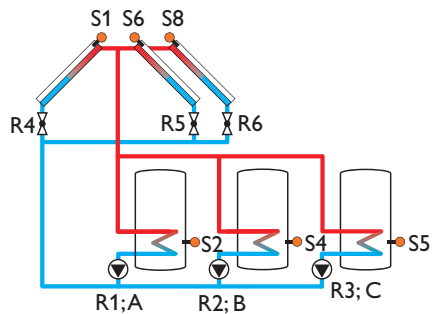

### System 3.3.3

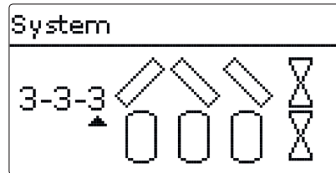

#### Sensors

Collector 1	S1
Store 1 base	S2
Store 2 base	S4
Store 3 base	S5
Collector 2	S6
Collector 3	S8

#### Relays; PWM/0-10

2-PV collector 1	R1
2-PV collector 2	R2
Solar pump	R3;A
2-PV store 1	R4
2-PV store 2	R5
2-PV store 3	R6
2-PV collector 3	R7

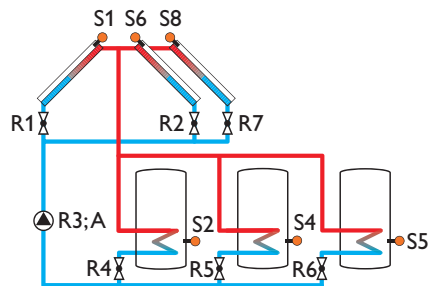



### System 3.3.4

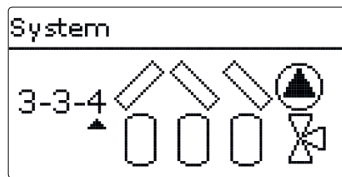

Sensors		Relays; PWM/0-10	
Collector 1	S1	Pump collector 1	R1;A
Store 1 base	S2	Pump collector 2	R2;B
Store 2 base	S4	3-PV store 1	R3
Store 3 base	S5	3-PV store 2	R4
Collector 2	S6	Pump collector 3	R5;C
Collector 3	S8		

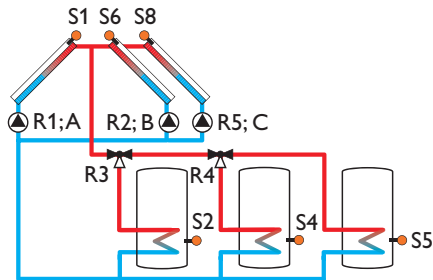

### System 3.3.5

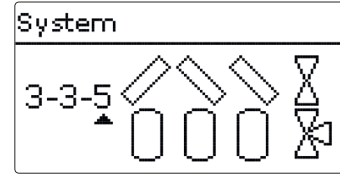

Sensors		Relays; PWM/0-10	
Collector 1	S1	2-PV collector 1	R1
Store 1 base	S2	2-PV collector 2	R2
Store 2 base	S4	Solar pump	R3;A
Store 3 base	S5	3-PV store 1	R4
Collector 2	S6	3-PV store 2	R5
Collector 3	S8	2-PV collector 3	R6

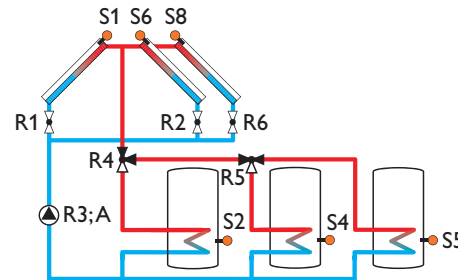

### System 3.4.1

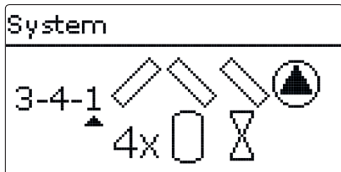

#### Sensors

Collector 1	S1
Store 1 base	S2
Store 2 base	S4
Store 3 base	S5
Collector 2	S6
Store 4 base	S7
Collector 3	S8

#### Relays; PWM/0-10

Pump collector 1	R1; A
Pump collector 2	R2; B
2-PV store 1	R3
2-PV store 2	R4
2-PV store 3	R5
2-PV store 4	R6
Pump collector 3	R7; C

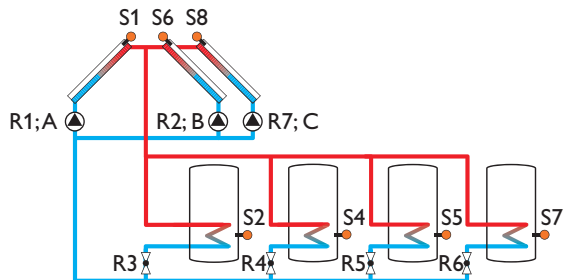

### System 3.4.2

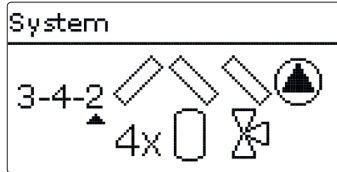

#### Sensors

Collector 1	S1
Store 1 base	S2
Store 2 base	S4
Store 3 base	S5
Collector 2	S6
Store 4 base	S7
Collector 3	S8

#### Relays; PWM/0-10

Pump collector 1	R1; A
Pump collector 2	R2; B
3-PV store 1	R3
3-PV store 2	R4
3-PV store 3	R5
Pump collector 3	R6; C
Collector 3	S8

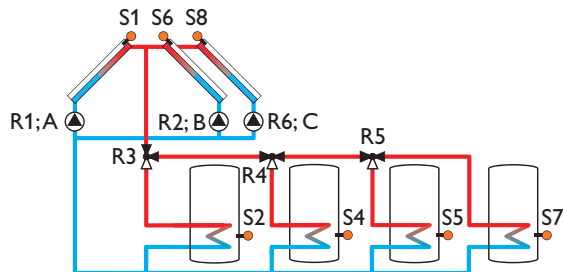

### System 3.4.3

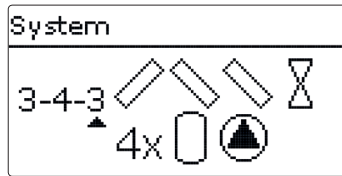

Sensors		Relays; PWM/0-10	
Collector 1	S1	Solar pump store 1	R1;A
Store 1 base	S2	Solar pump store 2	R2;B
Store 2 base	S4	Solar pump store 3	R3;C
Store 3 base	S5	Solar pump store 4	R4;D
Collector 2	S6	2-PV collector 1	R5
Store 4 base	S7	2-PV collector 2	R6
Collector 3	S8	2-PV collector 3	R7

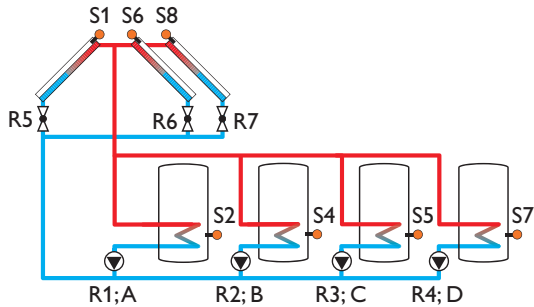

### System 3.4.4

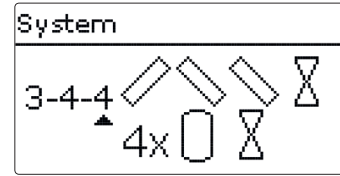

Sensors		Relays; PWM/0-10	
Collector 1	S1	2-PV collector 1	R1
Store 1 base	S2	2-PV collector 2	R2
Store 2 base	S4	Solar pump	R3;A
Store 3 base	S5	2-PV store 1	R4
Collector 2	S6	2-PV store 2	R5
Store 4 base	S7	2-PV store 3	R6
Collector 3	S8	2-PV store 4	R7
		2-PV collector 3	R8

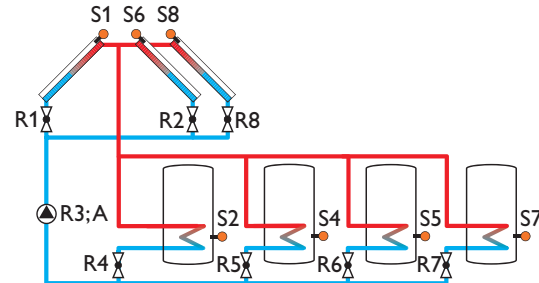

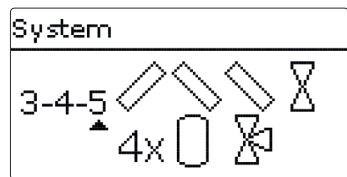

**Sensors**

Collector 1	S1
Store 1 base	S2
Store 2 base	S4
Store 3 base	S5
Collector 2	S6
Store 4 base	S7
Collector 3	S8

**Relays; PWM/0-10**

2-PV collector 1	R1
2-PV collector 2	R2
Solar pump	R3;A
3-PV store 1	R4
3-PV store 2	R5
3-PV store 3	R6
2-PV collector 3	R7

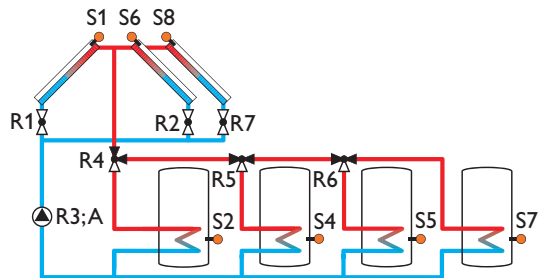

**6 Main menu**

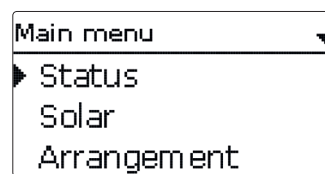

In this menu, the different menu areas can be selected.

The following menus are available:

- Status
- Solar
- Arrangement
- Heating
- HQM
- Basic settings
- SD card
- Manual mode
- User code
- Inputs/Modules

- ➔ Select the menu area by pressing buttons  $\uparrow$  and  $\downarrow$ .
- ➔ Press button  $\text{5}$  in order to enter the menu area selected.



**Note**

If no button is pressed for 1 min, the display illumination goes out. After 4 further minutes, the controller will display the home screen (see page 47).

- ➔ In order to get from the status menu into the main menu, press button  $\text{7}$ !

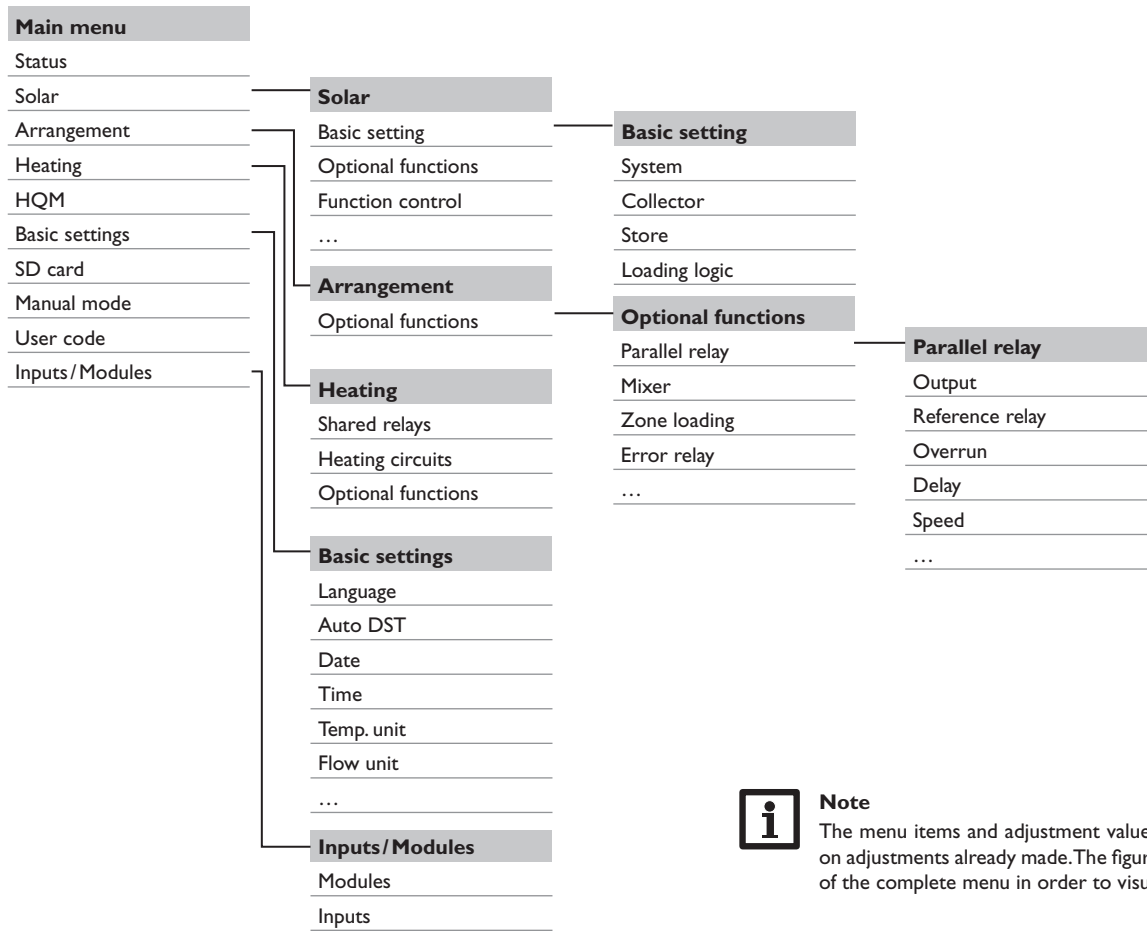



**Note**

The menu items and adjustment values selectable are variable depending on adjustments already made. The figure only shows an exemplary excerpt of the complete menu in order to visualise the menu structure.

## 7 Status

In the status menu of the controller, the status messages for every menu area can be found.

Use the buttons  and  for scrolling through the status menu.

HC 1			HC 2 static
▶ Op. mode	Auto		▶ Op. mode
Status	Day		Status
Flow	40 °C		Flow
			50 °C

At the end of each submenu, the menu item **Adjustment values** can be found.



Bypass		
▶ Pump	Off	
Bypass	96 °C	
Adj. values		

If **Adjustment values** is selected, the corresponding menu will open.

➔ In order to get back to the status menu, press button .

### 7.1 Measured/Balance values

In the **Status/Meas./Balance values** menu, all current measurement values as well as a range of balance values are displayed. Some of the menu items can be selected in order to enter a submenu.

Each sensor and relay is indicated with the component or function it has been allocated to. The symbol ▶ at the edge of the display next to a sensor allocated to a function, means that this sensor has several functions. Use buttons  and  to scroll to these functions. The sensors and relays of the controller and all modules connected are listed in numerical order.

### 7.2 Solar

The **Status/Solar** menu shows all status information of the solar system and all optional functions activated.

### 7.3 Arrangement

The **Status/Arrangement** menu shows all status information of all activated optional functions of the arrangement.

### 7.4 Heating

In the **Status/Heating** menu, the status of the demands and heating circuits activated as well as of the selected optional functions is indicated.

### 7.5 HQM

In the **Status/HQM** menu, all current measured values of the flow and return sensors, flow rate and power as well as heat quantities are indicated.

### 7.6 Messages

Status: Messages	
▶ Everything OK	
Restarts	1
Version	2.00



In the **Status/Messages** menu, error and warning messages are indicated.

During normal operation, the message **Everything OK** is indicated.

When a monitoring function from the function control is activated and detects a fault condition, a corresponding message will be indicated (see table page 61).

A message consists of the name of the monitoring function, a 4-digit error code and a short text description of the fault condition.

In order to acknowledge a message, proceed as follows:

- ➔ Select the code line of the desired message by pressing buttons  and .
- ➔ Acknowledge the message by pressing button .
- ➔ Confirm the security enquiry by selecting **Yes**.

When the installer user code has been entered, the menu item **Restarts** will appear below the messages. The value indicates the number of controller restarts since commissioning. This value cannot be reset.

Error code	Display	Monitoring function	Cause
0001	!Sensor fault!	Sensor line break	Sensor line broken
0002	!Sensor fault!	Sensor short circuit	Sensor line short-circuited
0011	!DT too high!	$\Delta T$ too high	Collector 50 K > than store to be loaded
0021	!Night circulation!	Night circulation	Betw. 11 p.m. and 5 a.m. col. temp > 40 °C
0031	!FL/RE interch.!	FL/RL interchanged	Col. temp. does not rise after switching on
0041	!Flow r. monit.!	Flow rate monitoring	No flow rate at sensor
0051	!Overpressure!	Overpressure monitoring	Max. system pressure exceeded
0052	!Low pressure!	Low pressure monitoring	System pressure below minimum
0061	!Data storage!	Storing and changing adjustments not possible	
0071	!RTC!	Time-controlled functions (e. g. night correction) not possible	
0081	!Store max. temp.	Maximum store temperature	St. max has been exceeded
0091	Restarts	Restart counter (non-adjustable)	Number of restarts since commissioning



### Note

The function control **Flow and return interchanged** according to the VDI guidelines 2169 can only correctly detect and indicate the error **0031 !FL/RE interch.!** if the collector sensor measures the temperature directly in the fluid at the collector outlet. If the collector sensor is not correctly placed, a false message may occur.

→ Place the collector sensor directly in the fluid at the collector outlet or deactivate the **Flow and return interchanged** function control.

## 7.7 Home screen

In the **Home screen** menu, the menu which will appear if no button is pressed for a longer period of time can be selected.

## 8 Solar

In this menu, all adjustments for the solar part of the arrangement can be made. The **Solar** menu consists of the following submenus:

- Basic setting
- Optional functions
- Function control
- Holiday function
- Expert

### 8.1 Basic setting

In this menu, all Basic settings for the solar part of the arrangement can be adjusted. In this menu, the hydraulic system, which is the basis for the arrangement, can be adjusted. The setting is divided into number of collector fields and stores as well as hydraulic variant.

The number of collector fields and stores as well as the hydraulic variant have normally already been adjusted in the commissioning menu.



### Note

If the setting is changed later on, all adjustments for the solar part of the arrangement will be set back to their factory settings.

If the change causes the solar system to require a relay or a PWM / 0-10-V output that has been allocated to an arrangement or heating function before, the relay or the PWM / 0-10V output respectively will be removed from the non-solar function.

The system selected is visualised by the corresponding number of store and collector symbols. The exemplary figure shows system 2.3.x with 2 collector fields and 3 stores.

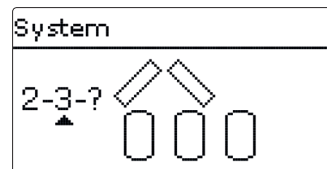

Afterwards, the hydraulic variant can be selected. The variant is visualised on the display by means of pump and valve symbols. The exemplary figure shows the display indicated when system 2.3.2 has been selected.

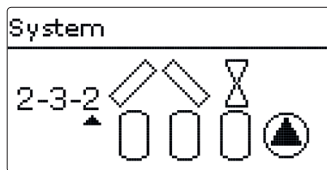

In this case, each collector field has a 2-port valve, the stores are loaded by means of pump logic. For an overview of the systems and their variants see page 21.

The controller supports up to 3 collector fields and up to 5 solar stores (with 2 or 3 collector fields only up to 4 solar stores).

The following items in the **Solar/Basic setting** menu will adjust to the system selected.

### Collector (1/2/3)

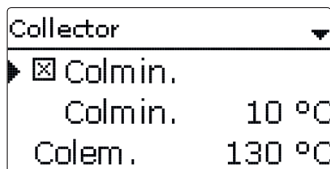

### Solar/Basic setting/Collector (1/2/3)

Adjustment channel	Description	Adjustment range/selection	Factory setting
Colmin.	Minimum collector limitation	Yes, No	Yes
Colmin.	Minimum collector temperature	10 ... 90 °C	10 °C
Colem.	Collector emergency temperature	80 ... 200 °C	130 °C

In systems with 2 or 3 collector fields, up to 3 separate menu items (Collector 1 and Collector 2) are displayed instead of **Collector**.

For each collector field, a Collector minimum limitation and a Collector emergency shutdown temperature can be adjusted.

### Store (1/2/3/4/5)

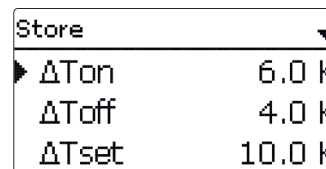

### Solar/Basic setting/Store (1/2/3/4/5)

Adjustment channel	Description	Adjustment range/selection	Factory setting
ΔTon	Switch-on temperature difference	1.0 ... 20.0 K	6.0 K
ΔToff	Switch-off temperature difference	0.5 ... 19.5 K	4.0 K
ΔTset	Set temperature difference	1.5 ... 30.0 K	10.0 K
Stset	Set store temperature	4 ... 95 °C	45 °C
Strmax	Maximum store temperature	4 ... 95 °C	60 °C
Priority	Store priority	1 ... 5	system dependent
HysSt	Hysteresis set and maximum store temperature	0.1 ... 10.0 K	2.0 K
Rise	Rise value	1.0 ... 20.0 K	2.0 K
tMin	Minimum runtime	0 ... 300 s	30 s
Min. speed	Minimum speed	20 ... 100 %	30 %
Store	Blocked for solar loading	Activated, Deactivated, Switch	Activated
Sensor	Switch input selection	-	-
Save/Delete function	Save or delete function	-	-

In systems with 2 or more stores, the corresponding number of separate menu items (**Store 1 to Store 5**) is displayed instead of **Store**.

For each store, an individual ΔT control, a Set and a Maximum temperature, the Priority (in multi-store systems), a Hysteresis, a Rise value, a Minimum runtime and a Minimum pump speed can be adjusted.



In multi-store systems with differing Set store/Maximum store temperatures, all stores are first loaded up to their **Set store** temperatures, then up to their **Maximum store temperatures** (according to their priority and the store sequence control). If one of the stores does not reach its set temperature, e. g. because the temperature difference is not sufficiently high, the subsequent store will be loaded past its set temperature up to its maximum temperature, if the switch-on condition is fulfilled.

The store number refers to the corresponding store sensor, not to the priority of the store. In the **Priority** channel, the corresponding store number is suggested as factory setting, but may be changed at will.

The store numbers refer to the sensors as follows:

Store 1 = Sensor S2

Store 2 = Sensor S4

Store 3 = Sensor S5

Store 4 = Sensor S6 or S7

Store 5 = Sensor S7

Each loading process will be carried out for the duration of the **Minimum runtime** at least, regardless of the switch-off condition.



#### Note

In order to prevent system damage, the controller is also equipped with an integrated store emergency shutdown, deactivating the complete solar system if one of the stores reaches 95 °C [200 °F].

## Loading logic

Load. logic	
Type	Store seq.
Load. break	2 min
Circ. t.	15 min

## Solar/Basic setting/Load. logic

Adjustment channel	Description	Adjustment range / selection	Factory setting
Type	Loading logic type	Store seq./Succ. loading	Store seq.
Load. break	Loading break time	1 ... 5 min	2 min
Circ. t.	Circulation time	1 ... 60 min	15 min
Break speed	Break speed option	Yes, No	No
Speed	Loading break time speed	20 ... 100%	30%
Spreaded loading	Spreaded loading option	Yes, No	No
$\Delta T$	Spread temperature difference	20 ... 90 K	40 K
Pump delay	Pump delay	Yes, No	No
Delay	Delay time	5 ... 600 s	15 s

In systems with 2 or more stores, loading logic adjustments can be made in this menu.

In systems with 1 store, only the menu item **Pump delay** will be available.

## Store sequence control

If the priority store cannot be loaded, the subordinate store next in priority will be checked. If useful heat can be added, it will be loaded for the circulation time. After the **Circulation time** has elapsed, the loading process will stop and the controller will monitor the increase in collector temperature during the **Loading break time**. If it increases by 2K, the break time timer will start again to allow the collector to gain more heat. If the collector temperature does not increase sufficiently, the subordinate store will be loaded again for the **Circulation time** as before.

As soon as the switch-on condition of the priority store is fulfilled, it will be loaded. If the switch-on condition of the priority store is not fulfilled, loading of the subordinate store will be continued. If the priority store reaches its maximum temperature, store sequence control will not be carried out.

## Successive loading

Successive loading means that the priority store will be loaded up to its maximum temperature. If it is reached, the next store available for heating will be loaded. If the temperature of the priority store falls below the set store temperature, the next store will no longer be loaded, regardless of whether the switch-on conditions of the priority store or of the subordinate store are fulfilled or not.

If all store have been loaded to their set temperature, the same process will take place until the stores have reached their maximum temperature.

Each loading process will be carried out for the **Minimum runtime** (Solar/Basic setting /Store) at least, regardless of the switch-off condition.

### Spreaded loading option

In multi-store systems without 3-port valves, a spreaded loading function can be activated: As soon as the adjustable **Spread temperature difference** between the collector and the priority store is reached, the next store will be loaded in parallel unless it is blocked. If the temperature difference falls by 2 K below the DT value, the pump will be switched off.

The collector temperature has to be higher than the store temperature.

### Relay

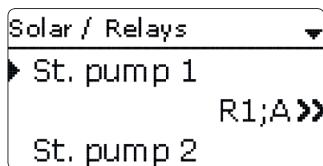

### Solar/Basic setting/Relay

Adjustment channel	Description	Adjustment range/selection	Factory setting
Relay	Relay display	system dependent	system dependent
PWM/0-10V	PWM/0-10V option	Yes, No	No
Output	Signal output selection	system dependent	system dependent
Signal	Signal type	PWM, 0-10V	PWM
Profile	Characteristic curve	Solar, Heating	Solar
Speed	Speed control	Yes, No	system dependent
Min.	Minimum speed	20 ... 100%	20%
Max.	Maximum speed	20 ... 100%	100%
Adapter	Adapter option	Yes, No	No
Inverted	Inverted switching option	Yes, No	No

Adjustment channel	Description	Adjustment range/selection	Factory setting
Blocking protection	Blocking protection option	Yes, No	No
Manual mode	Operating mode	Max, Auto, Min, Off	Auto

This submenu indicates the components to which the outputs of the system selected have been allocated. All adjustments required for the outputs can be made in this menu.

## 8.2 Optional functions

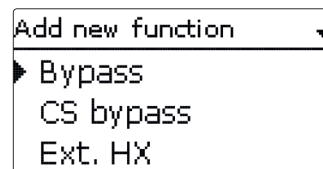

In this menu, additional functions can be selected and adjusted for the solar part of the arrangement.

The kind and number of optional functions offered depends on the previous adjustments.



### Note

For further information about adjusting optional functions, see page 14.

## Bypass

Bypass	
▶ Collector	1
Output	R.3
Type	Pump

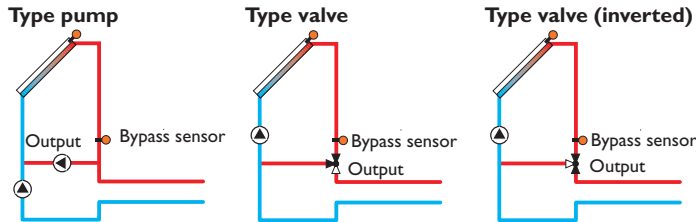

Exemplary schematics for the bypass variants

### Solar / Opt. functions / Add new function / Bypass

Adjustment channel	Description	Adjustment range / selection	Factory setting
Collector	Collector field	system dependent	system dependent
Output	Bypass output	system dependent	system dependent
Type	Variant (pump or valve logic)	Pump, Valve	Pump
Inverted	Valve logic inversion	Yes, No	No
Sensor	Bypass sensor	system dependent	system dependent
$\Delta T_{on}$	Bypass switch-on temperature difference	1.0 ... 20.0K	6.0K
$\Delta T_{off}$	Bypass switch-off temperature difference	0.5 ... 19.5K	4.0K
Funct.	Activation / Deactivation	Activated, Deactivated, Switch	Activated
Sensor	Switch input selection	-	-
Save / Delete function	Save or delete function	-	-

The **Bypass** function can be used for avoiding an energy loss directly after the solar circuit has been switched on. The still cold heat transfer medium in the pipework is diverted through a bypass past the store. Once the pipe is warm enough, the store can be loaded.

Type	
▶ <input checked="" type="radio"/> Valve	
<input type="radio"/> Pump	

Depending on whether the bypass is energised by a valve or by a second pump, a corresponding adjustment can be made in the menu item **Type**. Depending on the variant, different control logics are applied:

#### Type pump

In this version, a bypass pump is placed in front of the solar pump.

The bypass pump is first activated when store loading is possible. If the temperature difference between the **Bypass sensor** and the store sensor reaches the **Bypass switch-on temperature difference**, the bypass pump is switched off and the solar pump is switched on instead.

#### Type valve

A bypass valve is placed into the solar circuit.

The solar heat exchanger is first bypassed when store loading is possible. If the temperature difference between the **Bypass sensor** and the store sensor reaches the **Bypass switch-on temperature difference**, the bypass relay operates the valve and solar loading starts.

When the Valve type is selected, the option **Inverted** will be additionally available. When the Inverted option and the bypass circuit are activated, the relay switches on. If the temperature difference between the **Bypass sensor** and the store sensor reaches the **Bypass switch-on temperature difference**, the relay switches off.

## CS bypass

CS bypass	
▶ Collector	1,2
Irrad.	200 W/m <sup>2</sup>
Delay	120 s

## Solar/Opt. functions/Add new function/CS bypass

Adjustment channel	Description	Adjustment range/selection	Factory setting
Collector	Collector field	system dependent	system dependent
Irrad.	Switch-on irradiation	100 ... 500 W/m <sup>2</sup>	200 W/m <sup>2</sup>
Delay	Delay time	10 ... 300 s	120 s
Stmax off	Switch-on suppression	Yes, No	Yes
Funct.	Activation/Deactivation	Activated, Deactivated, Switch	Activated
Sensor	Switch input selection	-	-
Save/Delete function	Save or delete function	-	-

The **CS bypass function** is a further possibility to activate the solar circuit.

**Note**

To enable the use of the CS bypass function, a CS10 irradiation sensor has to be connected.

When the CS bypass function is activated, the Irradiation value is the switch-on condition for the collector circuit.

The output remains switched on if the irradiation value is exceeded for the Delay time. When solar loading begins or the irradiation value remains below the switch-on value for the delay time, the relay is switched off.

If the **Switch-on suppression** option off is activated, collector circuit activation will be suppressed as long as all store temperatures are above their respective maximum temperatures.

**Note**

If both the CS bypass and the bypass function are activated, the CS bypass will only affect the bypass. For this purpose, use S1 as the bypass sensor.

## External heat exchanger

Ext. HX	
▶ Output	R6
Store	1-3
Sensor HX	S3

## Solar/Opt. functions/Add new function/ Ext. HX

Adjustment channel	Description	Adjustment range/selection	Factory setting
Output	Output selection	system dependent	system dependent
Store	Store selection	system dependent	all stores
Sensor HX	Reference sensor external heat exchanger	system dependent	system dependent
Target temp.	Target temperature option	Yes, No	No
Sensor	Target temperature reference sensor	system dependent	system dependent
Targ. temp.	Target temperature	15 ... 95°C	60°C
ΔTon	Switch-on temperature difference	1.0 ... 20.0 K	10.0 K
ΔToff	Switch-off temperature difference	0.5 ... 19.5 K	5.0 K
Overrun	Overrun time	0 ... 15 min	2 min
Save/Delete function	Save or delete function	-	-

This function is used to link loading circuits that are separated by an external heat exchanger.

The allocated **Output** will be energised if one of the selected stores is being loaded and there is a temperature difference between the sensor of the corresponding store and the **Reference sensor external heat exchanger**.

Any number of the solar stores can be selected.

The output will be switched off if this temperature difference falls below the adjusted switch-off difference.

The **Reference sensor external heat exchanger** can be arbitrarily allocated.

**Note**

In systems in which stores are equipped with their own loading pumps, the heat exchanger relay controls the primary circuit pump.

If the **Target temperature** option is activated, the pump speed control logic will change. The controller will remain at the minimum pump speed until the temperature at the allocated sensor exceeds the adjusted target temperature.

If the temperature at the **Reference sensor target temperature** exceeds the target temperature by 5 K, the speed of the primary pump will be increased by 10%. If the temperature again increases by 5 K, the speed of the secondary pump will be adapted, too. Each temperature increase by 5 K will lead to an alternating adaptation of the primary and secondary pump speeds. If the temperature falls, the speed will be reduced correspondingly.

The heat exchanger is protected by a non-adjustable antifreeze function.

If the temperature at the heat exchanger sensor falls below the non-adjustable Antifreeze temperature (10°C), the controller will activate the secondary pump at 100% speed. The Antifreeze function will use heat from the store with the highest temperature. When all stores have reached 10°C, the secondary pump will be switched off. If the temperature at the reference sensor external heat exchanger exceeds the antifreeze temperature by 2K, the secondary pump will be switched off.

The heat exchanger antifreeze function works independently from solar loading.



#### Note

Because of the special hydraulics in systems with 2 or 3 collector fields, the **Target temperature** option will not work properly there.



#### Note

The heat exchanger is protected by a non-adjustable antifreeze function. Still, using a bypass is recommended.

## Tube collector function

Tube collector	
▶ Start	08:00
Stop	19:00
Run	30 s

## Solar/Opt. functions/Add new function/Tube collector

Adjustment channel	Description	Adjustment range/selection	Factory setting
Start	Start time frame	00:00 ... 23:00	08:00
Stop	Stop time frame	00:30 ... 23:30	19:00
Run	Pump runtime	5 ... 600 s	30 s
Break	Standstill interval	1 ... 60 min	30 min
Collector	Collector field	system dependent	system dependent
Stmax off	Maximum store temperature off	Yes, No	Yes
Func.	Activation/Deactivation	Activated, Deactivated, Switch	Activated
Sensor	Switch input selection	-	-
Save/Delete function	Save or delete function	-	-

This function is used for improving the switch-on behaviour in systems with non-ideal sensor positions (e. g. with some tube collectors).

This function operates within an adjusted time frame. It activates the collector circuit pump for an adjustable Runtime between adjustable Standstill intervals in order to compensate for the delayed temperature measurement.

If the runtime is set to more than 10 s, the pump will run at 100% for the first 10 s of the runtime. For the remaining runtime, the pump will be run at the adjusted minimum speed.

If the collector sensor is defective or the collector is blocked, this function is suppressed or switched off.

If the **Maximum store temperature off** option is activated and the temperature of the store to be loaded exceeds the maximum store temperature, the tube collector function will be suppressed.

## 2- and 3-collector systems

In systems with 2 or 3 collector fields, the tube collector function will be available for each individual collector field.

The tube collector function will remain inactive for a collector field which is used for solar loading.

### Target temperature

Target temp.	▼
▶ Targ. temp.	65 °C
Sensor	S9
Rise	2.0 K

### Solar/Opt. functions/Add new function/Target temp.

Adjustment channel	Description	Adjustment range/selection	Factory setting
Targ. temp.	Target temperature	20 ... 110 °C	65 °C
Sensor	Reference sensor	system dependent	system dependent
Rise	Rise value	1.0 ... 20.0 K	2.0 K
Funct.	Activation/Deactivation	Activated, Deactivated, Switch	Activated
Sensor	Switch input selection	-	-
Save/Delete function	Save or delete function	-	-

If the **Target temperature** function is activated, the pump speed control logic will change. The controller will remain at the minimum pump speed until the temperature at the allocated Sensor exceeds the adjusted Target temperature. Only then will the standard pump speed control start to operate. If the temperature at the allocated sensor changes by 1/10 of the adjusted rise value, the pump speed will be adjusted correspondingly.

If the **External heat exchanger** function with the **Target temperature** option (see page 52) is additionally activated, the target temperature control will pause while the external heat exchanger is being loaded. While the external heat exchanger is loaded, its own pump speed control will come into effect.

## Antifreeze

Antifreeze	▼
▶ Antifr. on	4 °C
Antifr. off	6 °C
Collector	1,2

### Solar/Opt. functions/Add new function/Antifreeze

Adjustment channel	Description	Adjustment range/selection	Factory setting
Antifr. on	Antifreeze switch-on temperature	-40 ... +15 °C	+4 °C
Antifr. off	Antifreeze switch-off temperature	-39 ... +16 °C	+6 °C
Collector	Collector field	system dependent	system dependent
Store (1...5)	Store succession order	system dependent	system dependent
Funct.	Activation/Deactivation	Activated, Deactivated, Switch	Activated
Sensor	Switch input selection	-	-
Save/Delete function	Save or delete function	-	-

The **Antifreeze** function activates the loading circuit between the collector and the store when the collector temperature falls below the adjusted **Antifreeze switch-on temperature**. This will protect the fluid against freezing or coagulating. If the **Antifreeze switch-off temperature** is exceeded, the solar pump will be switched off again.

Heat will be extracted from the stores according to the adjusted order. When all stores have reached their minimum temperature of 5 °C, the function becomes inactive.

If the function is activated, the pump will run at its maximum relative speed.



#### Note

Since this function uses the limited heat quantity of the store, the antifreeze function should be used in regions with few days of temperatures around the freezing point.



#### Note

In systems with 2 or 3 collector fields, 2 or 3 separate menus will be displayed.

## Backup heating suppression

BH suppress.	
▶ Output	R6
Store	1-3
<input type="checkbox"/> Stset	

### Solar/Opt. functions/Add new function/BH suppress.

Adjustment channel	Description	Adjustment range/selection	Factory setting
Output	Reference output	system dependent	system dependent
Store	Store selection	system dependent	system dependent
Stset	Set store temperature	Yes, No	No
Funct.	Activation/Deactivation	Activated, Deactivated, Switch	Activated
Sensor	Switch input selection	-	-
Save/Delete function	Save or delete function	-	-

The **Backup heating suppression** blocks the conventional backup heating of a store that is currently in solar loading.

This function is activated if a previously selected **Store** is being loaded by solar heat. Solar loading means that store loading is only carried out for energy supply and not for cooling purposes etc.

If the **Set temperature** option is activated, the backup heating will only be suppressed when the store temperature exceeds the **Set store temperature**.

## Parallel relay

Parallel relay	
▶ Output	R9
Store	1
Funct.	Activated

### Solar/Opt. functions/Add new function/Parallel relay

Adjustment channel	Description	Adjustment range/selection	Factory setting
Output	Parallel output	system dependent	system dependent
Store	Store selection	system dependent	system dependent
Funct.	Activation/Deactivation	Activated, Deactivated, Switch	Activated
Sensor	Switch input selection	-	-
Save/Delete function	Save or delete function	-	-

With this function, e. g. a valve can be controlled in parallel to a solar pump via a separate output.

Switch-on condition for the solar parallel relay function is that one or more of the selected stores is being loaded. If one of the selected stores is being loaded, the parallel output will be energised.

The parallel relay function operates regardless whether the store is subjected to regular solar loading or to a loading caused by a solar optional function (such as the collector cooling).



#### Note

If a relay is in the manual mode, the selected parallel output will not be energised.

## Cooling mode

Cooling mode	
Type	Syst. cool.
Store 1	1
Store 2	2

### Solar/Opt. functions/Add new function/Cooling mode

Adjustment channel	Description	Adjustment range/selection	Factory setting
Type	Cooling logic variant	Col. cool., Syst. cool., Off	Off
Tcolmax.	Collector maximum temperature	70 ... 190 °C	100 °C
Store (1 ... 5)	Store succession order	system dependent	system dependent
St. cooling	Store cooling option	Yes, No	No
ΔTon	Switch-on temperature difference	1.0 ... 30.0 K	20.0 K
ΔToff	Switch-off temperature difference	0.5 ... 29.5 K	15.0 K
Funct.	Activation/Deactivation	Activated, Deactivated, Switch	Activated
Sensor	Switch input selection	-	-
Save/Delete function	Save or delete function	-	-

In the **Cooling mode** menu, different cooling functions are available. They can be used for keeping the solar system operational for a longer time during strong solar irradiation.

For this purpose, the adjusted maximum store temperatures can be exceeded. The store order for this overloading can be adjusted. Additionally, each individual store can be excluded from this function.

2 variants are available for the cooling mode: **System cooling** and **Collector cooling**.

### Type system cooling

If the system cooling variant has been selected and the **Switch-on temperature difference** is exceeded, store loading will be continued even if the corresponding maximum temperature is exceeded, but only up to the emergency shutdown temperature. Store loading will continue until all stores have reached the emergency shutdown temperature or until the **Switch-off temperature difference** is reached.

### Type collector cooling

If the collector cooling variant has been selected, store loading will be continued or reactivated when the **Collector maximum temperature** is exceeded.

Store loading will continue until all stores have reached the **Emergency shutdown temperature** or until the collector temperature falls below the Collector maximum temperature by at least 5 K.

In systems with 2 or 3 collector fields, separate adjustments can be made for each collector field.

The control logic considers collector cooling operation as solar loading. The adjusted values for Delay, Minimum runtime etc. remain valid.

Additionally to each of the 2 variants, the **Store cooling option** can be activated.

### Store cooling option

When the store cooling option is activated, the controller aims to cool down the store during the night in order to prepare it for solar loading on the following day.

When the store cooling option is activated, the solar pump will be switched on if the Maximum store temperature is exceeded and the collector temperature falls below the store temperature. The solar pump will remain active until the store temperature falls below the adjusted Maximum store temperature.

The store order for the cooling is the same as in the overheating through system or collector cooling.



## Drainback option

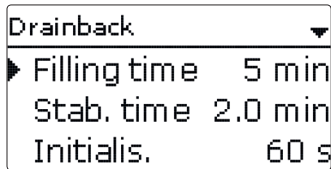

### Solar/Opt. functions/Add new function/Drainback

Adjustment channel	Description	Adjustment range/selection	Factory setting
Filling time	Drainback filling time	1 ... 30 min	5 min
Stab. time	Stabilisation time	1.0 ... 15.0 min	2.0 min
Initialis.	Initialisation time	1 ... 100 s	60 s
Booster	Booster option	Yes, No	No
Output	Output selection booster pump	system dependent	system dependent
Drain impulse	Drain impulse option	Yes, No	No
Delay	Delay time	1 ... 30 min	3 min
Duration	Drain impulse loading duration	1 ... 60 s	10 s
Funct.	Activation/Deactivation	Activated, Deactivated, Switch	Deactivated
Sensor	Switch input selection	-	-
Save/Delete function	Save or delete function	-	-

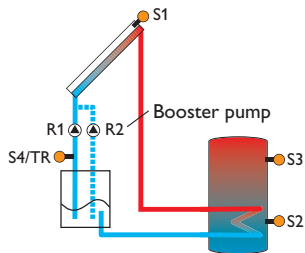

Exemplary drainback system layout (R2 = booster pump)

In a drainback system the heat transfer fluid will flow into a holding tank if solar loading does not take place. The drainback option initiates the filling process if solar loading is about to start. If the drainback option is activated, the following adjustment can be made.



#### Note

A drainback system requires additional components such as a holding tank. The drainback option should only be activated if all components required are properly installed.

The filling time can be adjusted using the parameter **Filling time**. During this period, the pump runs at 100% speed.

The parameter **Stabilisation time** is used for adjusting the period during which the switch-off condition will be ignored after the filling time has ended.

The parameter **Initialisation time** is used for adjusting the period during which the switch-on condition must be permanently fulfilled, before the filling process starts.

The **Booster** option is used for switching on a second pump when filling the solar system. The corresponding output is switched on at 100% speed for the duration of the filling time.

After the system has been emptied and the delay time elapsed, the **Drain impulse** option will switch on the solar pump for an adjustable **Duration**. Thus, a hydrostatic head will form in the flow pipe. When it falls back into the holding tank, water pockets remaining in the collector will be sucked down into the holding tank.



#### Note

If the drainback option is used in multi store systems, the **Break speed** option has to be activated in the **Solar/Basic setting/Loading logic** menu!

## Twin pump

Twin pump	
▶ Output	R6
Ref. relay	R5
Runtime	6 h

## Solar/Opt. functions/Add new function/Twin pump

Adjustment channel	Description	Adjustment range/selection	Factory setting
Output	Output selection	system dependent	system dependent
Ref. relay	Reference relay selection	system dependent	-
Runtime	Pump runtime	1 ... 48 h	6 h
Flow rate mon.	Flow rate monitoring option	Yes, No	No
Sen. flow rate	Flow rate sensor selection	IMP1 ... IMP3, Ga1, Ga2, Gd1, Gd2, FR1 (FlowRotor)	-
Delay	Delay time	1 ... 10 min	5 min
Funct.	Activation/Deactivation	Activated, Deactivated, Switch	Activated
Sensor	Switch input selection	-	-
Save/Delete function	Save or delete function	-	-

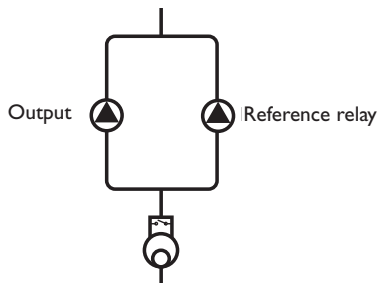

Exemplary figure of twin pumps in the solar flow with upstream flowmeter

The **Twin pump** function controls the equal distribution of pump runtime in systems with 2 equally usable pumps.

If the allocated **Output** has exceeded its adjusted **Runtime** and the next switch-on process is about to start, the **Reference relay** will be switched on instead. All characteristics are adopted.

If the reference relay has in turn exceeded its runtime as well, the first output will be switched on again in the next switch-on process.

Additionally, the **Flow rate monitoring** option can be activated in order to activate the twin pump in the case of a flow rate error.

If the flow rate monitoring function is activated, an error message will appear when no flow rate is detected at the allocated **Flow rate sensor** after the **Delay time** has elapsed. The active output is considered as defective and will be blocked until the error message has been acknowledged. The second output will be activated instead. The twin pump function will pause until the error message has been acknowledged.

When the error message is acknowledged, the controller runs a test during which it will energise the corresponding output and again monitor the flow rate.

## Heat dump

Heat dump	
► Output	R6
Type	Valve
ΔTValve	3.0 K

### Solar/Opt. functions/Add new function/Heat dump

Adjustment channel	Description	Adjustment range/selection	Factory setting
Output	Output selection	system dependent	system dependent
Type	Variant (pump or valve logic)	Valve, Pump	Valve
ΔTvalve	Valve logic temperature difference	0.0 ... 10.0 K	3.0 K
Collector	Collector selection	system dependent	1
Tcol.	Collector overtemperature	40 ... 190 °C	110 °C
Funct.	Activation/Deactivation	Activated, Deactivated, Switch	Activated
Sensor	Switch input selection	-	-
Save/Delete function	Save or delete function	-	-

### Type pump

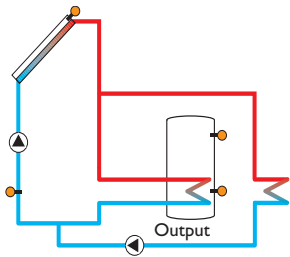

### Type valve

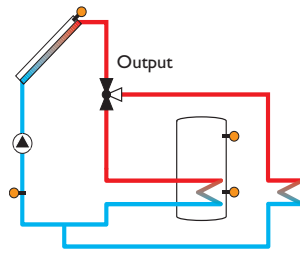

The **Heat dump** function can be used to direct excess heat generated by strong solar irradiation to an external heat exchanger (e. g. fan coil) in order to keep the collector temperature within the operating range.

Whether the heat dump is activated via an additional pump or a valve can be adjusted in the **Type** menu.

### Type pump

The allocated output will be energised with 100%, if the collector temperature reaches the adjusted switch-on temperature.

If the collector temperature falls by 5 K below the adjusted **Collector overtemperature**, the output will be switched off. In the Pump variant, the heat dump function works independently from solar loading.

### Type valve

If the collector temperature reaches the value  $[T_{col} - \Delta T_{Valve}]$ , the allocated output will be switched-on in order to open the valve. If the collector temperature reaches the **Collector overtemperature**, the solar pump will be activated. If the collector temperature falls by 5 K below the adjusted **Collector overtemperature**, the solar pump will be switched off again. If the collector temperature falls by 10 K below the switch-on temperature, the valve will be put into its initial position.

If one of the store temperatures exceeds its store maximum temperature by more than 10 K while the heat dump function is active, the function will be deactivated and an error message will appear. If the temperature falls below this value by the **Hysteresis maximum store temperature** (Solar/Basic setting/Store), the heat dump function will be released again.



### Note

The Switch-on collector temperature must be adjusted at least by 10 K lower than the Emergency switch-off temperature.

## Flow rate monitoring

Flow rate mon. ▾	
▶ Sensor	Imp.2
Ref. relay	R5
Store	1

### Solar/Opt. functions/Add new function/ Flow rate mon.

Adjustment channel	Description	Adjustment range/ selection	Factory setting
Sensor	Flow rate sensor selection	system dependent	-
Ref. relay	Reference relay selection	system dependent	-
Store	Store selection	system dependent	1
Time	Delay time	1 ... 300 s	30 s
Funct.	Activation/ Deactivation	Activated, Deactivated, Switch	Activated
Sensor	Switch input selection	-	-
Save/ Delete function	Save or delete function	-	-

The **Flow rate monitoring** function can be used to detect malfunctions that impede the flow rate and to switch off the corresponding output. This will prevent system damage, e.g. through a dry run of the pump.

If the flow rate monitoring function is activated, an error message will appear when no flow rate is detected at the allocated flow rate sensor after the delay time has elapsed.

- If a **Reference relay** has been selected, the flow rate monitoring function will become active when the allocated relay switches on. In the case of an error, the complete solar system will be shut down.
- If both a **Store** and a **Reference relay** have been selected, the flow rate monitoring function will become active when the allocated relay switches on. In the case of an error, the allocated store will be blocked until the error message has been acknowledged. The next store free for loading will be loaded instead.

The error message will appear both in the **Status/ Messages** menu and in the **Status/ Solar/ Flow rate monitoring** menu. It can be acknowledged in the **Status/ Solar/ Flow rate monitoring** menu. When the error message is acknowledged, the controller runs a test during which it will energise the relay and again monitor the flow rate.

## Pressure monitoring

Pressure monit. ▾	
▶ Sensor	Gd1
<input type="checkbox"/>	Low pressure
<input type="checkbox"/>	Overpressure



### Note

The Pressure monitoring function will only work when an RPD/RPS type Grundfos Direct Sensor™ is connected.

### Solar/Opt. functions/Add new function/ Pressure monit.

Adjustment channel	Description	Adjustment range/ selection	Factory setting
Sensor	Pressure sensor selection	S6	-
Low pressure	Low pressure monitoring option	Yes, No	No
On	Switch-on threshold	0.0 ... 9.7 bar	0.7 bar
Off	Switch-off threshold	0.1 ... 9.8 bar	1.0 bar
Shutdown	Shutdown option	Yes, No	No
Overpressure	Overpressure monitoring option	Yes, No	No
On	Switch-on threshold	0.3 ... 10.0 bar	5.5 bar
Off	Switch-off threshold	0.2 ... 9.9 bar	5.0 bar
Shutdown	Shutdown option	Yes, No	No
Funct.	Activation/ Deactivation	Activated, Deactivated, Switch	Activated
Sensor	Switch input selection	-	-
Save/ Delete function	Save or delete function	-	-

The **Pressure monitoring** function can be used for detecting overpressure or low pressure conditions inside the system, and if necessary to shut down the affected system components in order to avoid system damage.

### Low pressure monitoring

If the system pressure falls below the adjustable switch-on value **On**, an error message will appear.

If the **Shutdown** option has been activated for the low pressure monitoring function, the solar system will be shut down as well in the case of a fault condition.

When the pressure reaches or exceeds the adjustable Switch-off value **Off**, the system is switched on again.



#### Note

For the **Low pressure monitoring** function, **Off** always is at least 0.1 bar higher than **On**. The corresponding adjustment ranges will automatically adapt to that.

### Overpressure monitoring

If the system pressure exceeds the adjustable switch-on value **On**, an error message will appear.

If the **Shutdown** option has been activated for the overpressure monitoring function, the solar system will be shut down as well in the case of a fault condition.

When the pressure reaches or falls below the adjustable Switch-off value **Off**, the system is switched on again.



#### Note

For the **Overpressure monitoring** function, **On** always is at least 0.1 bar higher than **Off**. The corresponding adjustment ranges will automatically adapt to that.

## 8.3 Function control

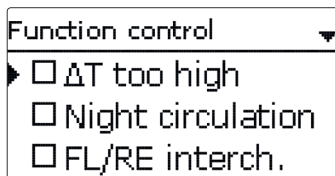

#### Note

Only if the installer code is entered (see page 93), will the function control menu be available.

### Solar/Function control

Adjustment channel	Description	Adjustment range/ selection	Factory setting
$\Delta T$ too high	DT monitoring option	Yes, No	No
Night circulation	Night circulation monitoring option	Yes, No	No
FL/RL interch.	FL/RE interchange monitoring option	Yes, No	No
Stmax	Maximum store temperature monitoring option	Yes, No	Yes
Store	Store selection	system dependent	system dependent

### $\Delta T$ monitoring option

This function is used for monitoring the temperature difference. The message  **$\Delta T$  too high** will be shown if solar loading has been carried out for a period of 20 min with a differential higher than 50K. Normal operation is not cancelled or inhibited, but the system should be checked for the cause of the warning.

Possible causes are:

- pump power too weak
- hydraulic blockage of a system component
- circulation problems in the collector
- air inside the system
- defective valve/ defective pump

### Night circulation

This function can be used for detecting thermal circulation inside the solar circuit that leads to an unwanted cooling of the store. A warning message will appear when one of the following conditions has been detected for at least 1 min during the period between 11 p.m. and 5 a.m.:

- collector temperature exceeds 40 °C
- the temperature difference exceeds  $\Delta T_{on}$

The delay time of 1 min ensures that the message is not triggered by short-term fault conditions.

Possible causes are:

- defective non-return valves
- defective valve
- wrongly adjusted time

## Flow and return interchanged

This function is used for detecting an interchange of the flow and return pipe or a badly placed collector sensor. For this purpose, the collector temperature is monitored for plausibility during the switch-on phases of the solar pump. The message **FL/RE interchanged** will appear, when the plausibility criteria have not been met 5 times in a row.



### Note

The function control **Flow and return interchanged** according to the VDI guidelines 2169 can only correctly detect and indicate the error **0031 !FL/RE interchanged!** if the collector sensor measures the temperature directly in the fluid at the collector outlet. If the collector sensor is not correctly placed, a false message may occur.

- Place the collector sensor directly in the fluid at the collector outlet or deactivate the **Flow and return interchanged** function control.

## Maximum store temperature

This function is used for detecting and indicating if the adjusted maximum store temperature has been exceeded. The controller compares the current store temperature to the adjusted maximum store temperature, thus monitoring the store loading circuits. The maximum store temperature is considered exceeded when the temperature measured at the store sensor exceeds the adjusted maximum store temperature by at least 5 K. The monitoring becomes active again as soon as the store temperature falls below the adjusted maximum store temperature.

In the **Store** channel, the store or stores to be monitored can be selected.

A possible cause for an unwanted exceedance of the maximum store temperature is a defective valve.

## 8.4 Holiday function

Holiday function	
▶ Cooling	Col. cool.
Tcolmax.	100 °C
Store 1	1

## Solar/Holiday function

Adjustment channel	Description	Adjustment range/selection	Factory setting
Cooling	Cooling logic variant	Col. cool., Syst. cool., Off	Off
TColmax.	Collector maximum temperature	70 ... 190 °C	100 °C
Store (1 ... 5)	Store succession order	system dependent	system dependent
St. cooling	Store cooling option	Yes, No	Yes
ΔTon	Switch-on temperature difference	1.0 ... 30.0 K	20.0 K
ΔToff	Switch-off temperature difference	0.5 ... 29.5 K	15.0 K
Stmax (1 ... 5)	Store cooling temperature	4 ... 95 °C	40 °C
Heat dump	Store heat dump	Yes, No	No
Output	Output selection	system dependent	-
Sensor	Sensor selection	system dependent	-
TStoreOn	Switch-on temperature	5 ... 95 °C	65 °C
TStoreOff	Switch-off temperature	4 ... 94 °C	45 °C

The holiday function is used for operating the system when no water consumption is expected, e. g. during a holiday absence. This function cools down the system in order to reduce the thermal load.

Only if the holiday function has been activated with the parameter Days of absence will the adjustments described in the following become active.

4 cooling functions are available: system cooling, collector cooling, store cooling and store heat dump.

### Type system cooling

If the system cooling variant has been selected and the switch-on temperature difference is exceeded, store loading will continue even if the corresponding maximum temperature is exceeded, but only up to the emergency shutdown temperature. Store loading continues until all stores have reached the emergency shutdown temperature or until the switch-off temperature difference is reached.

### Type collector cooling

If the collector cooling variant has been selected, store loading will continue when the collector maximum temperature is exceeded.

Store loading continues until all stores have reached the emergency shutdown temperature or until the collector temperature falls below the collector maximum temperature by at least 5 K.

The control logic regards collector cooling operation as solar loading. The adjusted values for delay, minimum runtime, etc. remain valid.

Additionally to each of the two variants, the **Store cooling option** can be activated.

### Store cooling option

When the Store cooling option is activated, the controller aims to cool down the store during the night in order to prepare it for solar loading on the following day.

When the store cooling option is activated, the solar pump will be switched on if the Maximum store temperature is exceeded and the collector temperature falls below the store temperature. The solar pump will remain active until the store temperature falls below the adjusted Maximum store temperature. The store order for the cooling is the same as in the overheating through system- or collector cooling.

### Store heat dump option

The store heat dump option can be used to direct excess heat generated by strong solar irradiation from the store to an external heat exchanger (e. g. fan coil) or radiator in order to prevent the collectors from overheating. The store heat dump function is independent of the solar system and can be activated with the parameter

**Heat dump**. The function uses the adjustable switch-on and switch-off temperature differences **TStoreOn** and **TStoreOff**.

If the temperature measured at the sensor selected reaches the switch-on temperature, the output selected will be energised until the temperature difference falls below the switch-off value. The parameter Days of absence can be used for entering the number of days for a holiday absence.

If the parameter is set to a value higher than 0, the function becomes active using the adjustments that have previously been made in the Holiday menu. The days will be counted backwards at 00:00. If the value is set to 0, the function is deactivated.



#### Note

The parameter **Days of absence** can be accessed via button 7. The remaining days of absence will be indicated in the status menu.

## 8.5 Solar expert menu

```

Expert
└─  Flow sensor
    Sensor
└─  Return sensor
  
```

## Solar/Expert

Adjustment channel	Description	Adjustment range/selection	Factory setting
Flow sensor	Flow sensor option	Yes, No	No
Sensor	Flow sensor selection	system dependent	-
Return sensor	Return sensor option	Yes, No	No
Sensor	Return sensor selection	system dependent	-

The **Expert** menu is only available when the installer user code has been entered. In the expert menu, a flow and a return sensor can be selected and allocated. The activated sensors are then used to detect the switch-off condition.

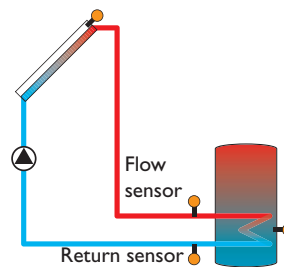

Example of flow and return sensor positions



#### Note:

Because of the special hydraulics in systems with 2 or 3 collectors, this function will not work properly there.

## 9 Arrangement

```

Arr. / Opt. funct.
└─  Parallel relay
    Add new function
    back
  
```

In this menu, all adjustments for the non-solar part of the arrangement can be made. Up to 16 optional functions can be selected and adjusted.

## 9.1 Optional functions

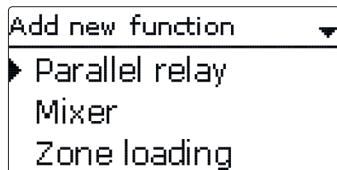

In this menu, optional functions can be selected and adjusted for the arrangement. The kind and number of optional functions offered depends on the previous adjustments.



### Note

For further information about adjusting optional functions, see page 14.

### Parallel relay

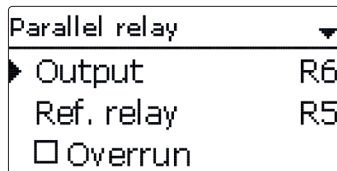

### Arrangement/Opt. functions/Add new function/Parallel relay

Adjustment channel	Description	Adjustment range/selection	Factory setting
Output	Output selection	system dependent	system dependent
Ref. relay	Reference relay selection	system dependent	-
Overrun	Overrun option	Yes, No	No
Duration	Overrun time	1 ... 30 min	1 min
Delay	Delay option	Yes, No	No
Duration	Delay time	1 ... 30 min	1 min
Funct.	Activation/Deactivation	Activated, Deactivated, Switch	Activated
Sensor	Switch input selection	-	-
Save/Delete function	Save or delete function	-	-

The **Parallel relay** function can be used for operating an allocated **Output** along-

side a selected **Reference relay**. With this function, e. g. a valve can be controlled in parallel to the pump via a separate output.

If the **Overrun** option is activated, the **Output** remains switched on for the adjusted **Overrun time** after the **Reference relay** has been switched off.

If the **Delay** option is activated, the **Output** will be energised after the adjusted **Duration** has elapsed. If the **Reference relay** is switched off again during the delay time, the Parallel output will not be switched on at all.



### Note

If a relay is in the manual mode, the selected output will not be energised.

### Mixer

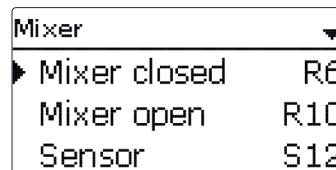

### Arrangement/Opt. functions/Add new function/Mixer

Adjustment channel	Description	Adjustment range/selection	Factory setting
Mixer closed	Output selection mixer closed	system dependent	system dependent
Mixer open	Output selection mixer open	system dependent	system dependent
Sensor	Sensor selection	system dependent	system dependent
TMixer	Mixer target temperature	0 ... 130 °C	60 °C
Interval	Mixer interval	1 ... 20 s	4 s
Funct.	Activation/Deactivation	Activated, Deactivated, Switch	Activated
Sensor	Switch input selection	-	-
Save/Delete function	Save or delete function	-	-

The **Mixer** function can be used to adjust the actual flow temperature to the desired **Mixer target temperature**. The mixer is opened or closed in pulses depending on this deviation. The pulses are determined by the adjustable **Interval**. The pause is determined by the difference between the actual value and the set value.



## Zone loading

Zone loading	
▶ Output	R7
Sensor top	S9
Sensor base	S10

### Arrangement / Opt. functions / Add new function / Zone loading

Adjustment channel	Description	Adjustment range / selection	Factory setting
Output	Output selection	system dependent	system dependent
Sensor top	Top sensor selection	system dependent	system dependent
Sensor base	Base sensor selection	system dependent	system dependent
Ton	Switch-on temperature	0 ... 94 °C	45 °C
Toff	Switch-off temperature	1 ... 95 °C	60 °C
Timer	Timer option	Yes, No	No
Funct.	Activation / Deactivation	Activated, Deactivated, Switch	Activated
Sensor	Switch input selection	-	-
Save / Delete function	Save or delete function	-	-

The **Zone loading** function can be used for loading a store zone between 2 sensors. For monitoring the switch-on and switch-off conditions, 2 sensors are used. The switch-on and switch-off temperatures are used as reference parameters.

If the measured temperatures at both allocated sensors fall below the adjusted **Switch-on temperature**, the output will be energised. The output will be switched off again if the temperature at both sensors has exceeded the **Switch-off temperature**.

If one of the two sensors is defective, zone loading is suppressed or switched off.



#### Note

For information on timer adjustment see page 12.

## Error relay

Error relay	
▶ Output	R7
Funct.	Activated
Save function	

### Arrangement / Opt. functions / Add new function / Error relay

Adjustment channel	Description	Adjustment range / selection	Factory setting
Output	Output selection	system dependent	system dependent
Funct.	Activation / Deactivation	Activated, Deactivated, Switch	Activated
Sensor	Switch input selection	-	-
Save / Delete function	Save or delete function	-	-

The **Error relay** function can be used for operating an output in the case of an error. Thus, e. g. a signalling device can be connected in order to signal errors.

If the error relay function is activated, the allocated output will operate when a fault occurs. If the Flow rate monitoring and/or Pressure monitoring function is additionally activated, the allocated Output will also operate in the case of a flow rate or pressure error.

## Heat exchange

Heat exchange	
Output	R7
Sen. Source	S9
Sen. Sink	S10

## Arrangement/Opt. functions/Add new function/ Heat exchange

Adjustment channel	Description	Adjustment range/selection	Factory setting
Output	Output selection	system dependent	system dependent
Sen. source	Heat source sensor selection	system dependent	system dependent
Sen. sink	Heat sink sensor selection	system dependent	system dependent
$\Delta T_{on}$	Switch-on temperature difference	1.0 ... 30.0K	6.0K
$\Delta T_{off}$	Switch-off temperature difference	0.5 ... 29.5K	4.0K
$\Delta T_{set}$	Set temperature difference	1.5 ... 40.0K	10.0K
TMax	Maximum temperature of the store to be loaded	10 ... 95 °C	60 °C
TMin	Minimum temperature of the store to be loaded	10 ... 95 °C	10 °C
Timer	Timer option	Yes, No	No
Funct.	Activation / Deactivation	Activated, Deactivated, Switch	Activated
Sensor	Switch input selection	-	-
Save / Delete function	Save or delete function	-	-

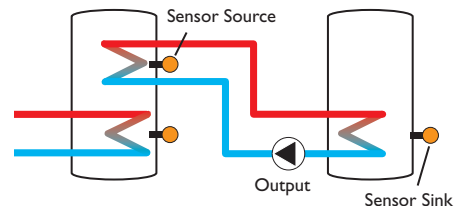

The **Heat exchange** function can be used for transferring heat from a heat source to a heat sink.

The allocated **Output** is energised when all switch-on conditions are fulfilled:

- the temperature difference between the allocated sensors has exceeded the switch-on temperature difference
- the temperature difference between the allocated sensors has not fallen below the switch-off temperature difference
- the temperature at the heat source sensor has exceeded the minimum temperature
- the temperature at the heat sink sensor is below the maximum temperature
- one of the adjusted time frames is active (if the Timer option is selected)

If the **temperature difference** exceeds the adjusted **Set** value by 1/10 of the rise value, the pump speed increases by one step (1 %).

When the **Timer** option is activated, a timer is indicated in which time frames for the function can be adjusted.

**Note**

For information on timer adjustment see page 12.

## Solid fuel boiler

Solid fuel boiler	
► Output	R6
Sen. boiler	S3
Sen. store	S7

### Arrangement / Opt. functions / Add new function / Solid fuel boiler

Adjustment channel	Description	Adjustment range / selection	Factory setting
Output	Output selection	system dependent	system dependent
Sen. boiler	Solid fuel boiler sensor selection	system dependent	system dependent
Sen. store	Store sensor selection	system dependent	system dependent
$\Delta T_{on}$	Switch-on temperature difference	2.0 ... 30.0 K	6.0 K
$\Delta T_{off}$	Switch-off temperature difference	1.0 ... 29.0 K	4.0 K
$\Delta T_{set}$	Set temperature difference	3.0 ... 40.0 K	10.0 K
TStoremax	Maximum temperature	10 ... 95 °C	60 °C
TMin boiler	Minimum temperature	10 ... 95 °C	60 °C
Target temp.	Target temperature option	Yes, No	No
Targ. temp.	Target temperature	30 ... 85 °C	65 °C
Sensor	Reference sensor	system dependent	system dependent
Mixer	Mixer option	Yes, No	No
Mixer closed	Output selection mixer closed	system dependent	system dependent
Mixer open	Output selection mixer open	system dependent	system dependent
Sensor	Mixer sensor selection	system dependent	system dependent
$\Delta T_{open}$	Temperature difference mixer open	0.5 ... 30.0 K	5.0 K
$\Delta T_{closed}$	Temperature difference mixer closed	0.0 ... 29.5 K	2.0 K
Interval	Mixer interval	1 ... 20 s	4 s

Adjustment channel	Description	Adjustment range / selection	Factory setting
Funct.	Activation / Deactivation	Activated, Deactivated, Switch	Activated
Sensor	Switch input selection	-	-
Save / Delete function	Save or delete function	-	-

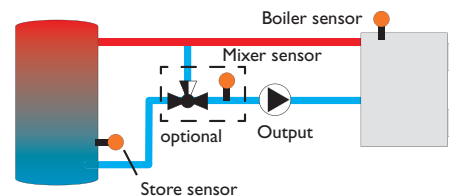

The **Solid fuel boiler** function can be used for transferring heat from a solid fuel boiler to a store.

The allocated **Output** is energised when all switch-on conditions are fulfilled:

- the temperature difference between the allocated sensors has exceeded the switch-on temperature difference
- the temperature difference between the allocated sensors has not fallen below the switch-off temperature difference
- the temperature at the solid fuel boiler sensor has exceeded the minimum temperature
- the temperature at the store sensor is below the maximum temperature
- one of the adjusted time frames is active (if the Timer option is selected)

When the **Set temperature difference** is exceeded, pump speed control starts.

For every deviation by 1/10 of the adjusted rise value, the pump speed will be adjusted by 1%.

If the **Target temperature** option is activated, the pump speed control logic will change. The controller will remain at the minimum pump speed until the temperature at the allocated sensor exceeds the adjusted target temperature.

The **Mixer** option can be used to keep the boiler return temperature above **TMin boiler**. The pulses are determined by the adjustable **Interval**.

Circulation	
Output	R7
Type	Thermal
Sensor	S7

### Arrangement/Opt. functions/Add new function/Circulation

Adjustment channel	Description	Adjustment range/selection	Factory setting
Output	Output selection	system dependent	system dependent
Type	Variant	Demand,Thermal, Timer,Therm.+Timer, Dem.+Timer	Thermal
Sensor	Circulation sensor selection	system dependent	system dependent
Ton	Switch-on temperature	10 ... 59 °C	40 °C
Toff	Switch-off temperature	11 ... 60 °C	45 °C
Timer	Timer option	Yes, No	No
Delay	Demand switch-on delay	0 ... 3 s	0 s
Runtime	Circulation pump runtime	01:00 ... 15:00 min	03:00 min
Break time	Circulation pump break time	10 ... 60 min	30 min
Funct.	Activation/Deactivation	Activated, Deactivated, Switch	Activated
Sensor	Switch input selection	-	-
Save/Delete function	Save or delete function	-	-

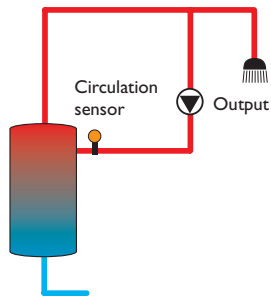

The **Circulation** function can be used for controlling a circulation pump.

For the control logic, 5 variants are available:

- Thermal
- Timer
- Thermal + Timer
- Demand
- Demand + Timer

If one of the variants is selected, the corresponding adjustment channels will appear:

#### Thermal

The temperature at the allocated Sensor is monitored. The allocated output switches on when the temperature falls below the adjusted Switch-on temperature. If the temperature exceeds the Switch-off temperature, the output switches off.

#### Timer

The output switches on during the adjusted time frames, outside of them it switches off.

#### Thermal + Timer

The output operates when the switch-on conditions of both above-mentioned variants are fulfilled.

#### Demand

The allocated flow switch is monitored for circuit continuity. If circuit continuity is detected at the flow switch, the output will switch on for the adjusted Runtime. After the runtime has ended, the output switches off. During the adjusted Break time, the output remains switched off even if continuity is detected at the flow switch.

#### Demand + Timer

The output operates when the switch-on conditions of both above-mentioned variants are fulfilled. When the **Timer**, **Therm. + Timer** or **Demand + Timer** variant is activated, a timer is indicated in which time frames for the function can be adjusted.



#### Note

If the flow switch is connected to the input S1 ... S12, continuity must be detected for at least 5 s for the controller to react, 1s if the flow switch is connected to an impulse input.



#### Note

For information on timer adjustment see page 12.

## Return preheating

Ret. preheat.	▼
► Output	R6
Sen. return	S7
Sen. source	S3

### Arrangement / Opt. functions / Add new function / Ret. preheat.

Adjustment channel	Description	Adjustment range / selection	Factory setting
Output	Output selection	system dependent	system dependent
Sen. return	Return sensor selection	system dependent	system dependent
Sen. source	Heat source sensor selection	system dependent	system dependent
$\Delta T_{on}$	Switch-on temperature difference	2.0 ... 30.0 K	6.0 K
$\Delta T_{off}$	Switch-off temperature difference	1.0 ... 29.0 K	4.0 K
Summer off	Summer switch-off option	Yes, No	No
Sensor	Outdoor sensor selection	system dependent	system dependent
Toff	Switch-off temperature	10 ... 60 °C	20 °C
Funct.	Activation / Deactivation	Activated, Deactivated, Switch	Activated
Sensor	Switch input selection	-	-
Save / Delete function	Save or delete function	-	-

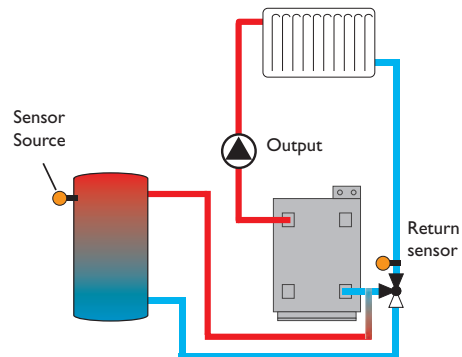

The **Return preheating** function can be used for transferring heat from a heat source to the heating circuit return.

The allocated output is energised when all switch-on conditions are fulfilled:

- the temperature difference between the allocated sensors has exceeded the switch-on temperature difference
- the temperature difference between the allocated sensors has not fallen below the switch-off temperature difference
- if Summer off is activated, the temperature at the outdoor temperature sensor falls below the adjusted outdoor temperature value

With the Summer switch-off option, the return preheating can be suppressed outside the heating period.

## Function block

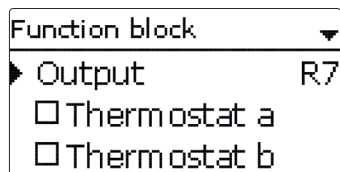

## Arrangement/Opt. functions/Add new function/Function block

Adjustment channel	Description	Adjustment range/selection	Factory setting
Output	Output selection	system dependent	system dependent
Thermostat a	Thermostat a option	Yes, No	No
Th-a on	Switch-on temperature thermostat a	-40 ... +250 °C	+40 °C
Th-a off	Switch-off temperature thermostat a	-40 ... +250 °C	+45 °C
Sensor	Sensor thermostat a	system dependent	system dependent
Thermostat b	Thermostat b option	Yes, No	No
Th-b on	Switch-on temperature thermostat b	-40 ... +250 °C	+40 °C
Th-b off	Switch-off temperature thermostat b	-40 ... +250 °C	+45 °C
Sensor	Sensor thermostat b	system dependent	system dependent
ΔT function	Differential function	Yes, No	No
ΔTon	Switch-on temperature difference	1.0 ... 50.0K	5.0K
ΔToff	Switch-off temperature difference	0.5 ... 49.5K	3.0K
ΔTset	Set temperature difference	3 ... 100K	10K
Sen. source	Heat source sensor	system dependent	system dependent
Sen. sink	Heat sink sensor	system dependent	system dependent
Timer	Timer option	Yes, No	No
Ref. output	Reference output option	Yes, No	No
Mode	Reference output mode	OR, AND, NOR, NAND	OR
Output	Reference output 1	all outputs	-

Adjustment channel	Description	Adjustment range/selection	Factory setting
Output	Reference output 2	all outputs	-
Output	Reference output 3	all outputs	-
Output	Reference output 4	all outputs	-
Output	Reference output 5	all outputs	-
Funct.	Activation / Deactivation	Activated, Deactivated, Switch	Activated
Sensor	Switch input selection	-	-
Save / Delete function	Save or delete function	-	-

In addition to the pre-defined optional functions, function blocks consisting of thermostat functions, timer, differential and reference output functions are available. With the help of these function blocks, further components and functions respectively can be controlled.

To each function block, sensors and outputs available can be allocated. Sensors already in use can be allocated again without impeding their control functions.

Within a function block the functions are interconnected (AND gate). This means that the switching conditions of all the activated functions have to be fulfilled for switching the allocated output. As soon as one condition is not fulfilled, the output will switch off.

**Thermostat function**

The switching condition for the thermostat function is considered fulfilled when the adjusted switch-on temperature (Th(x) on) is reached.

The switching condition for the thermostat function is considered unfulfilled when the adjusted switch-off temperature (Th(x) off) is reached.

Allocate the reference sensor in the **Sensor** channel.

Adjust the maximum temperature limitation with  $Th(x)_{off} > Th(x)_{on}$  and the minimum temperature limitation with  $Th(x)_{on} > Th(x)_{off}$ . The temperatures cannot be set to an identical value.

## $\Delta T$ function

The switching condition for the  $\Delta T$  function is considered fulfilled when the adjusted switch-on temperature ( $\Delta T_{on}$ ) is reached.

The switching condition for the  $\Delta T$  function is considered unfulfilled when the adjusted switch-off temperature ( $\Delta T_{off}$ ) is reached.

The  $\Delta T$  function is equipped with a speed control function. A set temperature difference and a minimum speed can be adjusted. The non-adjustable rise value is 2K.

## Reference output

Up to 5 Reference outputs can be selected. Whether the reference outputs are to be switched in series (AND), in parallel (OR), in series + inverted (NAND) or in parallel + inverted (NOR) can be adjusted in the **Mode** channel.

## OR mode

If at least one of the reference outputs is switched on, the switching condition for the reference output function is considered fulfilled.

If none of the reference outputs is switched on, the switching condition for the reference output function is considered unfulfilled.

## NOR mode

If none of the reference outputs is switched on, the switching condition for the reference output function is considered fulfilled.

If at least one of the reference outputs is switched on, the switching condition for the reference output function is considered unfulfilled.

## AND mode

If all reference outputs are switched on, the switching condition for the reference output function is considered fulfilled.

If at least one of the reference outputs is switched off, the switching condition for the reference output function is considered unfulfilled.

## NAND mode

If at least one of the reference outputs is switched off, the switching condition for the reference output function is considered fulfilled.

If all reference outputs are switched on, the switching condition for the reference output function is considered unfulfilled.



## Note

If more than one function block has been activated, outputs of numerically higher function blocks may not be used as reference outputs.



## Note

For information on timer adjustment see page 12.

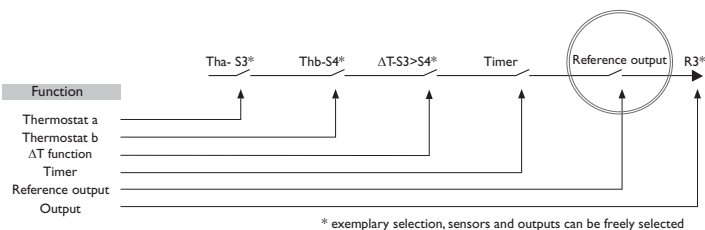

\* exemplary selection, sensors and outputs can be freely selected

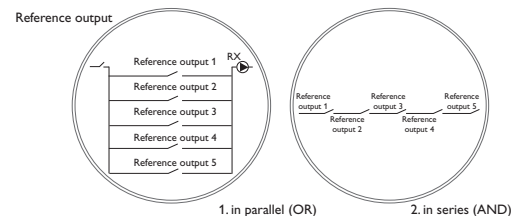

## Irradiation switch

Irrad. switch	
▶ Output	R7
Irrad.	200 W/m <sup>2</sup>
Duration	2 min

### Arrangement/Opt. functions/Add new function/Irrad. switch

Adjustment channel	Description	Adjustment range/selection	Factory setting
Output	Output selection	system dependent	system dependent
Irrad.	Switch-on irradiation	50 ... 1000 W/m <sup>2</sup>	200 W/m <sup>2</sup>
Duration	Switch-on duration	0 ... 30 min	2 min
Inverted	Inverted switching option	Yes, No	No
Funct.	Activation/Deactivation	Activated, Deactivated, Switch	Activated
Sensor	Switch input selection	-	-
Save/Delete function	Save or delete function	-	-

The **Irradiation switch** function can be used for operating an output depending on the measured irradiation value.

The allocated output will be switched on if the adjusted irradiation value remains exceeded for the adjusted duration. If the irradiation falls below the adjusted irradiation value for the adjusted duration, the output will be switched off.

If the **Inverted** option is activated, the output will operate vice versa.

## Return mixing function

Ret. mixing	
▶ Mixer open	R7
Mixer closed	R8
Sen. store	S9

### Arrangement/Opt. functions/Add new function/Ret. mixing

Adjustment channel	Description	Adjustment range/selection	Factory setting
Mixer open	Output selection mixer open	system dependent	system dependent
Mixer closed	Output selection mixer closed	system dependent	system dependent
Sen. store	Store sensor allocation	system dependent	system dependent
Sen. HC ret.	HC return sensor allocation	system dependent	system dependent
Sen. boiler ret.	Boiler return sensor allocation	system dependent	system dependent
ΔTon	Switch-on temperature difference	1.0 ... 25.0 K	5.0 K
ΔToff	Switch-off temperature difference	0.5 ... 24.0 K	3.0 K
ΔTset	Set temperature difference	-20 ... +25 K	+7 K
Tmax	Maximum boiler return temperature	10 ... 80 °C	60 °C
Interval	Mixer interval	1 ... 20 s	2 s
HC intern.	Detection controller heating circuit active	Yes, No	No
HC intern.	Heating circuit allocation	HC1 ... HC7	-
Runtime	Mixer runtime	10 ... 600 s	105 s
Time	Time of automatic adjustment	00:00 ... 23:45	00:00
Funct.	Activation/Deactivation	Activated, Deactivated, Switch	Activated
Sensor	Switch input selection	-	-
Save/Delete function	Save or delete function	-	-



The **Return mixing** function can be used for solar heating backup.

Solar heat from the store is mixed into the heating circuit return by means of a mixing valve in order to add heat to the heating circuit. The controller compares the temperature in the centre of the store to the heating circuit return temperature. If the store temperature exceeds the heating circuit return temperature by the **Switch-on temperature difference**, the mixer will be used to add solar heat from the store to the heating circuit return. The mixer will be opened or closed in pulses depending on this deviation. The pulses are determined by the adjustable **Interval**. The pause is determined by the difference between the actual value and the set value.

Thus, the heating circuit return temperature increases by the  $\Delta T_{set}$  value. The adjustable **Maximum boiler return temperature** limits the mixing temperature. If the store temperature falls below the heating circuit return temperature by the **Switch-off temperature difference**, the mixer will close.

If the mixing temperature exceeds **TMax** by more than 5 K, a message will appear in the status menu.

The **Runtime** defines the time needed for the mixer to switch from its initial position to the end position. The **Time** defines the point in time when the mixer is set to its initial or ending position respectively.

### HC internal option

If the **HC internal** option is activated, the return mixing function will only become active when a selectable heating circuit connected to the same controller is active, too. For this purpose, the heating circuit selected has to be controlled by the controller or by a module connected.

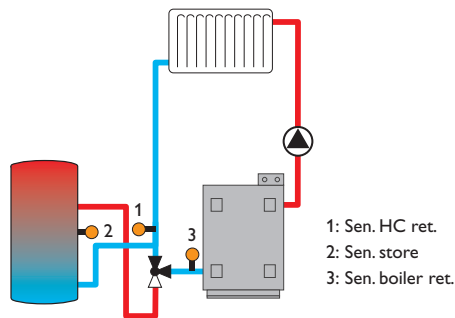

## 10 Heating

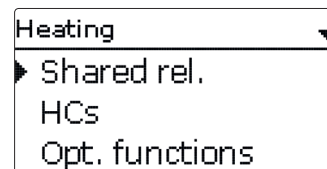

In this menu, all adjustments for the heating part of the arrangement or for the heating circuits respectively can be made.

Shared relays for demands, loading pumps or valves can be activated, heating circuits can be configured and optional functions can be selected and adjusted.

In this menu, the screed drying function can be activated and adjusted.

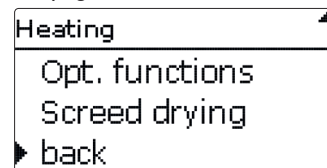

### 10.1 Shared relays

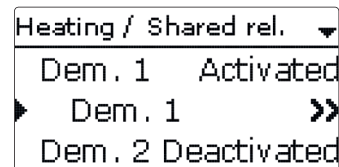

In this menu, adjustments for heat generators which are shared by several heating circuits and their optional functions can be made.

Shared relays will be available for selection under **Virtual** in the heating circuits and in the relay allocation channels of the corresponding optional functions of the Heating menu. This way, several heating circuits and optional functions (heating) can demand the same heat source.



#### Note

Activate and adjust the shared relays first. They will then be available in the heating circuits and optional functions.

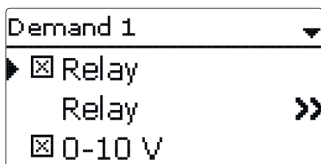

### Heating/Shared rel.

Adjustment channel	Description	Adjustment range/ selection	Factory setting
Dem. 1 (2)	Demand 1 (2)	Activated, Deactivated	Deactivated
Relay	Relay option	Yes, No	No
Relay	Relay submenu	-	-
Relay	Relay selection	system dependent	system dependent
Boiler pr. min	Option for boiler protection min	Yes, No	No
Tmin	Minimum boiler temperature	10... 90 °C	55 °C
Boiler pr. max	Option for boiler protection max	Yes, No	No
Tmax	Maximum boiler temperature	20... 95 °C	90 °C
Sen. boiler	Boiler sensor selection	system dependent	S4
0-10V	0-10V option	Yes, No	No
0-10V	0-10V submenu	-	-
Output	Output selection	-, A, B, C, D	-
TSet 1	Lower boiler temperature	10... 85 °C	10 °C
Volt 1	Lower voltage	1.0... 10.0V	1.0V
TSet 2	Upper boiler temperature	15... 90 °C	80 °C
Volt 2	Upper voltage	1.0... 10.0V	8.0V
Tmin	Minimum value set boiler temperature	10... 89 °C	10 °C
Tmax	Maximum value set boiler temperature	11... 90 °C	80 °C
ΔTFlow	Increase for the set flow temperature	0... 20K	5K
Sen. flow	Flow sensor option	Yes, No	No
Sensor	Flow sensor selection	system dependent	S4
Interval	Monitoring period	10... 600 s	30 s
Hysteresis	Correction hysteresis	0.5... 20.0K	1.0K
Correction	Correction of the voltage signal	0.0... 1.0V	0.1V
Min. runtime	Minimum runtime option	Yes, No	No
tMin.	Minimum runtime	0... 120 min	10 min
Manual mode	Operating mode for shared relays	Max, Auto, Off, Min	Auto

back

In this menu, up to 2 heating demands can be activated and adjusted.

**Activated demands will be available for selection in the output allocation channels of the backup heating in heating circuits and heating optional functions. This way, several heating circuits and optional functions can demand the same heat source.**

Every demand can be carried out by means of a relay and/or a 0-10V output. If both the relay and the 0-10V option are activated, the demand will use both outputs in parallel.

### Relay option

If the **Relay** option is activated, the submenu **Relay** will appear, in which a relay can be allocated to the demand.

The options **Boiler protection min** and **Boiler protection max** can be activated for the demand via a relay, allowing temperature-dependent control of the boiler demand. For this purpose, a **Boiler sensor** has to be selected.

The **Boiler protection min** option is used for protecting an older type boiler against cooling. If the temperature falls below the adjusted minimum temperature, the allocated relay will be energised until the minimum temperature is exceeded by 5 K.

The **Boiler protection max** option is used for protecting an older type boiler against overheating. If the adjusted Maximum temperature is exceeded, the allocated relay will be switched off until the temperature falls by 5K below the maximum temperature.

Example:

The potential-free relay 14 can be allocated to the shared relay **Demand 1**. R14 will then become available for potential-free boiler demand in the heating circuits and e. g. the DHW heating function.

## 0-10 V option

If the **0-10 V** option is activated, the submenu 0-10 V will appear, in which a 0-10 V output can be allocated to the demand.

With this option, the controller can demand modulating heat generators equipped with a 0-10 V interface.

The characteristic curve of the 0-10 V signal as a function of the set boiler temperature is defined by means of 2 set points according to the specifications of the boiler manufacturer. At a temperature of **TSet 1**, the voltage signal of the heat generator is **Volt 1**. At a temperature of **TSet 2**, the voltage signal of the heat generator is **Volt 2**. The controller automatically calculates the characteristic curve resulting from these values.

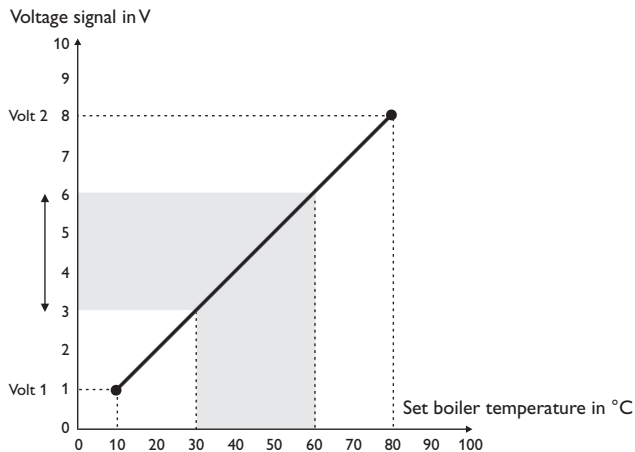

By means of the adjustment channels **TMax** and **TMin** the maximum and minimum values for the set boiler temperature can be defined.

When the **Flow sensor option** is activated, the controller will monitor whether the heat generator actually reaches the desired set temperature and will, if necessary, adjust the voltage signal accordingly. In order to do so, the controller will check the temperature at the boiler flow sensor when the **Interval** has elapsed. If the temperature measured deviates from the boiler set temperature by more than the **Hysteresis** value, the voltage signal will be adapted by the **Correction** value. This process will be repeated until the temperature measured is identical to the set boiler temperature.

When the **Minimum runtime** option is activated, a **Minimum runtime** can be adjusted for the demand.



### Note

If the 0-10 V demand is used for DHW heating, the voltage signal will always be identical to **Tmax**.

## 10.2 Heating circuits

The controller has 2 mixed weather-compensated heating circuits and is able to control up to 5 external mixed heating circuits by means of extension modules.

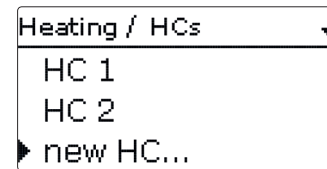

If one or more extension modules are connected, they have to be registered with the controller. Only registered modules will be available in the heating circuit selection.

If **new HC...** is selected for the first time, the first heating circuit is allocated to the controller.

In the heating circuit menu, relays for the heating circuit pump and the heating circuit mixer can be selected.

HC		▼
▶ Heat. sys.		➤➤
HC pump	R7	
Mixer open	R8	

3 free relays are required for a mixed heating circuit.

If the measured flow temperature deviates from the Set flow temperature, the mixer will be activated in order to adjust the flow temperature correspondingly.

The mixer runtime can be adjusted with the parameter **Interval**.

### Heating system submenu

In the **Heating system** submenu, a **Mode** for the heating circuit control can be selected and adjusted. 5 modes are available:

- Constant
- Characteristic curve
- Linear
- Room influence
- Room

Heat. sys.		▼
▶ Mode	Constant	
Tflowset	45 °C	
Tflowmin	20 °C	

The **Constant** mode aims to keep the set flow temperature at a constant value which can be adjusted by means of the parameter TFlowset.

Set flow temperature = set temperature + remote control + day correction or night correction

Heat. sys.		▼
▶ Mode	Curve	
Curve	1.0	
Tflowmin	20 °C	

If the **Curve** mode is selected, the controller will calculate a set flow temperature by means of the outdoor temperature and the **Heating curve selected**. In both cases, the dial setting of the remote control and the controller Day correction or Night correction will be added.

Set flow temperature = heating curve temperature + remote control + day correction or night correction.

The Remote control allows manual adjustment of the heating curve ( $\pm 15$  K). Furthermore, the heating circuit can be switched off or a rapid heat-up can be carried out by means of the remote control.

Heating circuit switched off means that the heating circuit pump is switched off and the mixer closed. The flow temperature is boosted to maximum for rapid heat-up when the remote control is set to rapid heat-up.

The calculated set flow temperature is limited by the adjusted values of the parameters **Set flow temperature** and **Minimum flow temperature**.

Maximum flow temperature  $\geq$  set flow temperature  $\geq$  minimum flow temperature

If the outdoor temperature sensor is defective, an error message will be indicated. For the duration of this condition, the maximum flow temperature -5 K is assumed as the set flow temperature in the **Curve** and **Linear** mode.

In the **Linear** mode the flow temperature curve will be calculated depending on the outdoor temperature by 2 points. At a temperature of **TOutdoor 1** the set flow temperature is **TFlow 1**. At a temperature of **TOutdoor 2** the set flow temperature is **TFlow 2**. The controller automatically calculates the characteristic curve resulting from these values.

Heat. sys. ▾	
▶ Mode	Linear
TOutdoor 1	20 °C
TFlow 1	20 °C

By means of the adjustment channels **TFlowmax** and **TFlowmin** the maximum and minimum values for the set flow temperature can be defined.

In the **Room influence** mode, the weather-compensated set flow temperature will be expanded by a demand-based room control. The parameter **Room factor** can be used for determining the intensity of the room influence.

The controller will calculate the set flow temperature using the heating system Curve plus the room influence:

Set flow temperature = set temperature + remote control + day correction or night correction + room influence.

In order to calculate the deviation of the room temperature from the adjusted set value, at least one sensor-type room thermostat is required. The adjustments can be made in the **Room thermostats** submenu, **Room therm. (1 ... 5)**.

Heat. sys. ▾	
▶ Mode	Room infl.
Curve	1.0
Room factor	5

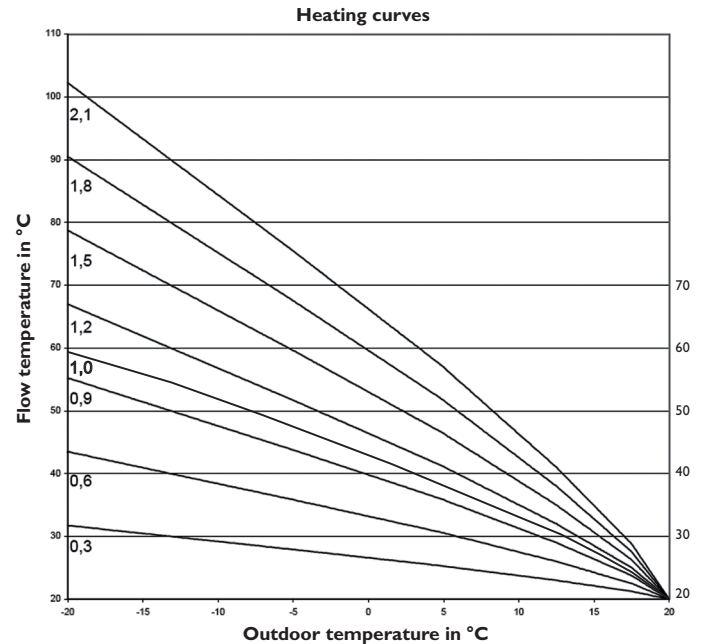

In the **Room** mode, the controller will calculate the set flow temperature by means of the room temperature, the outdoor temperature will not be taken into account.

The parameters **Day/Night correction** and **Timer** will not be indicated.

The start value of the set flow temperature can be influenced by the parameter **TStart**.

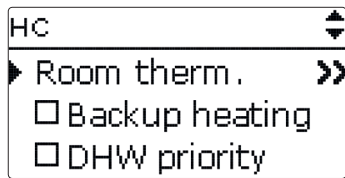

In order to calculate the deviation of the room temperature from the adjusted set value, a room thermostat is required. The adjustments can be made using the parameter **RTH(1 ... 5)**. For this purpose, select **Sensor** in the **Type** adjustment channel.

The adjustments of all activated room thermostats will be taken into account. The controller will calculate the average value of the deviations measured and correct the set flow temperature correspondingly.

#### Room thermostat option

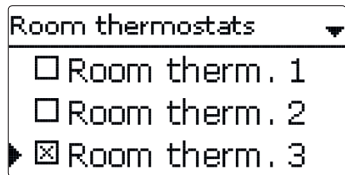

With the **Room thermostat** option, up to 5 room thermostats can be integrated into the control logic.

To each room thermostat, a sensor input can be allocated. The temperature at the allocated sensor is monitored. If the measured temperature exceeds the adjusted **Set room temperature** at all activated room thermostats and if the parameter **HC off** is activated, the heating circuit will switch off.

Common room thermostats with potential-free outputs can be used alternatively. In this case, **Switch** must be selected in the **Type** channel. The corresponding input must beforehand be set to Switch in the Inputs/Modules menu. Only inputs set to switch will be displayed in the channel **Sen. RTH** as possible inputs for a switch type room thermostat.

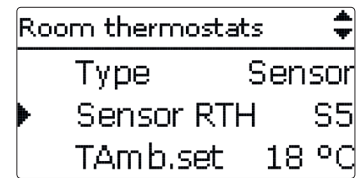

When the **Timer** option is activated, a timer is indicated in which time frames for the function can be adjusted. Outside these time frames, the adjusted room temperature decreases by the **Correction** value.



#### Note

For information on timer adjustment see page 12.

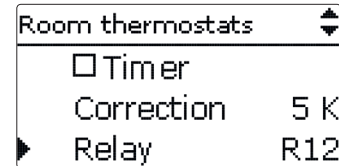

To each room thermostat, an additional relay can be allocated. The relay will switch on when the temperature falls below the adjusted room temperature. This way, the room in question can be excluded from the heating circuit via a valve as long as the desired room temperature is reached.

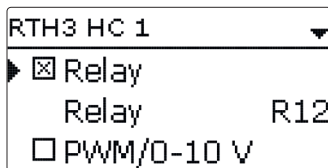

With the parameter **RTH**, the room thermostat can be temporarily deactivated or re-activated respectively. All adjustments remain stored.

### Correction timer

With the **Timer**, the day/night operation can be adjusted. During day phases, the set flow temperature is increased by the adjusted **day correction** value, during night phases it is decreased by the **night correction** value (night setback).

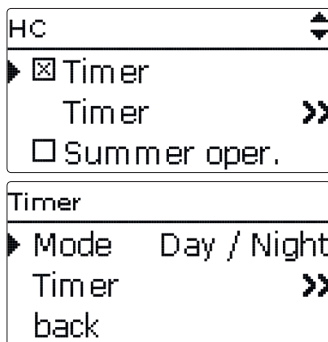

The parameter **Mode** is used for selecting between the following correction modes:

**Day/Night:** A reduced set flow temperature (night correction) is used during Night operation.

**Day/Off:** The heating circuit and the optionally activated backup heating are switched off during night operation.

The **Timer HC** parameter can be used for adjusting the time frames for day operation.

### Summer operation

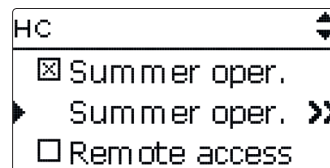

For summer operation, 2 different modes are available:

**Day:** If the outdoor temperature exceeds the **Summer temperature day**, the heating circuit will switch off.

**Day/Night:** The parameters **Daytime on** and **Daytime off** can be used for adjusting a time frame for the summer operation. If the outdoor temperature exceeds the **Summer temperature day** within the adjusted time frame, the heating circuit will switch off.

Outside the adjusted time frame the **Summer temperature night** is valid.

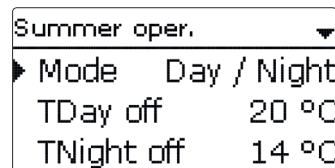

### Remote access

With the parameter **Remote access** different types of remote access to the controller can be activated.

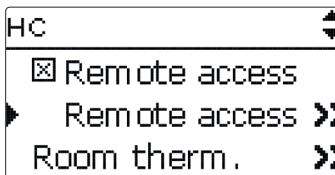

### Note

In the sensor selection menu, only outputs which have previously been selected as the input for remote access in the **Inputs/Modules** menu will be available.

Remote access	
▶ Mode	BAS
Sen. BAS	S8
back	

The following types of remote access are possible:

**Remote control:** A device which allows manual adjustment of the heating curve, thus influencing the set flow temperature.

→ In order to use a remote control, set the **Mode** to **Fern**.

**Room control unit:** A device incorporating a remote control as well as an additional operating mode switch.

→ In order to use a room control unit, set the **Mode** to **BAS**.

The operating mode switch of the room control unit is used for adjusting the operating mode of the controller. If a room control unit is used, the operating mode can be adjusted by means of the room control unit only. The controller menu will only allow the activation of the operating mode **Holiday**.

**App:** An app can be used for remote access.

Mode	
▶ <input checked="" type="radio"/> App	
<input type="radio"/> Fern	
<input type="radio"/> BAS	

→ In order to use an app, set the **Mode** to **App**.

If you use an app, the operating mode can be adjusted in the controller menu as well as in the app.

## Backup heating

For the **Backup heating** of the heating circuit, 3 modes are available:

In the **Thermostat** mode, the set flow temperature will be compared to a store reference sensor.

In the **Zone** mode, the set flow temperature will be compared to 2 store reference sensors. The switching conditions have to be fulfilled at both reference sensors.

In the **On/Off** mode, the backup heating will be activated when the heating circuit pump is switched on for heating.

Backup heating	
Mode	Zone
▶ Output	Dem.1
Sensor 1	S6

In the **Demand** submenu, the modes **Standard** and **Demand** are available. If **Standard** is selected, the output can be adjusted.

BH HC 1	
▶ Mode	Standard
<input type="checkbox"/> Relay	
<input type="checkbox"/> PWM/0-10 V	

If **Demand** is selected, a demand has to be activated and adjusted in the **Heating/Shared relays** menu first. If Adjustment values is selected, the **Heating/Shared relays/Demand** menu will open.

BH HC 1	
▶ Mode	Demand
Output	Dem.1
Adj. values	➤➤

In the correction mode **Day / Off** (see page 79) the heating circuit and the backup heating will be completely switched off during the night operation. The **Starting optimisation** option can be used for activating the backup heating before the day operation in order to heat the store to a sufficiently high temperature. The **Stopping optimisation** option can be used for deactivating the backup heating before the start of the night operation.



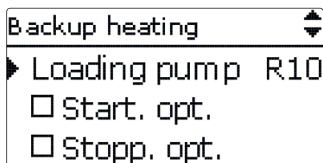

If **SFB off** is activated, backup heating will be suppressed when a selected solid fuel boiler is active.

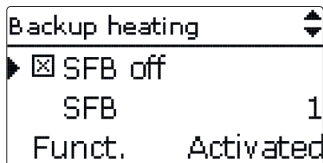

If **Solar off** is activated, backup heating will be suppressed when a selected **Store** is being loaded.

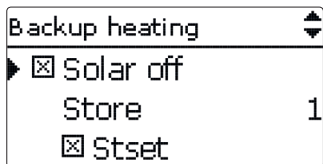

If the **Set temperature** option is activated, the backup heating will only be suppressed when the store temperature exceeds the **Set store temperature**. At first, backup heating is activated and can be temporarily deactivated.

### DHW priority

If the parameter **DHW priority** is activated, the heating circuit will be switched off and the backup heating be suppressed as long as DHW heating takes place which has previously been activated in the **Heating/Optional functions** menu.

### Chimney sweeper function

The chimney sweeper function can be used for enabling a quick access to measurement conditions without menu operation for the chimney sweeper.

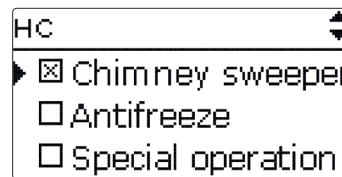

The chimney sweeper function is activated in all heating circuits by default. The chimney sweeper mode can be activated by pressing button **6** for 5 s

In the chimney sweeper mode, the heating circuit mixer opens, the heating circuit pump and the backup heating contact are activated. While the chimney sweeper mode is active, the directional pad is flashing red. Additionally, **Chimney sweeper** and a countdown of 30 min are indicated on the display.

When the countdown has elapsed, the chimney sweeper mode is automatically deactivated. If, during the countdown, button **6** is again pressed for more than 5 s, the chimney sweeper mode will stop.

### Antifreeze function

The antifreeze function of the heating circuit can be used to temporarily activate an inactive heating circuit during sudden temperature drop in order to protect it against frost damage.

The temperature at the sensor selected will be monitored. If the temperature falls below the adjusted antifreeze temperature, the heating circuit will be activated until the antifreeze temperature is exceeded by 2 K, but at least for 30 min.

### Special operation

For the **Special operation** option, 2 variants are available:

- Cooling
- Heat dump

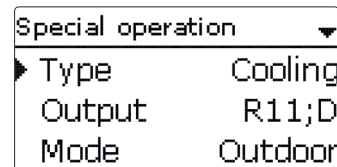

The **Cooling** variant is used for cooling via the heating circuit. 3 modes are available:

- Outdoor
- External switch
- Both

In the **Outdoor** mode, cooling will be activated if the **outdoor temperature cooling** is exceeded.

In the **External switch** mode, cooling will be activated by means of an external switch.

In the **both** mode, both switching conditions are valid for cooling.

In the **Cooling system** submenu, the cooling logic can be adjusted. For the cooling logic, 2 modes are available:

- Linear
- Constant

In the **Linear** mode, the set flow temperature will be calculated as in the heating system mode **Linear**.

The **Constant** mode aims to keep the set flow temperature at a constant value which can be adjusted by means of the parameter **TFlow**.

If the **Timer** option is activated, a time frame can be adjusted in which the cooling will be active.

If the **Dew point switch** option is activated, an output can be allocated to the dew point switch. If the dew point switch detects condensation, cooling will be interrupted.

Special operation	
Type	Heat dump
Sensor	S7
Ton	85 °C

The **Heat dump** variant is used for diverting excess heat to the heating circuit in order to keep the system temperatures within the operating range. For this purpose, the temperature measured at the allocated sensor **Sensor** will be monitored. If the temperature at the allocated sensor exceeds the **Switch-on temperature**, the **Set flow temperature** will be controlled to reach the adjusted value. If the temperature at the allocated sensor falls below the adjusted **Switch-off temperature**, the heat dump function will switch off.

## Energy saving operation

Energy saving	
Sen. return	S10
ΔToff	4 K
Break	15 min

The **Energy saving operation** is used for optimising the energy consumption of the heating circuit pump. For this purpose an additional sensor in the heating circuit return is required. The controller monitors the temperature difference between the flow and the return of the heating circuit. If the temperature difference falls below the **Switch-off difference**, the controller will deactivate the heating circuit pump for the adjusted **Break time**. After the break time has elapsed, the pump will be activated for the **Runtime**. If the temperature difference is higher than the switch-off difference, the pump will remain active. If the temperature difference is below the switch-off difference, the break time will start again.

## Heating/Heating circuits/New HC.../ Internal or Module 1...5

Adjustment channel	Description	Adjustment range/ selection	Factory setting
Heat. sys.	Heating system submenu	-	-
Mode	Heating system operating mode	Linear, Constant, Curve, Room , Room infl.	Characteristic curve
Curve	Heating curve	0.3... 3.0	1.0
Room factor	Room influence factor	1... 10	5
TFlowset	Set flow temperature	10... 90 °C	45 °C
TOutdoor 1	Lower outdoor temperature	-20... +20 °C	+20 °C
TFlow 1	Lower set flow temperature	20... 90 °C	20 °C
TOutdoor 2	Upper outdoor temperature	-20... +20 °C	-20 °C
TFlow 2	Upper set flow temperature	20... 90 °C	70 °C
TStart	Start temperature	20... 60 °C	40 °C
TFlowmin	Minimum flow temperature	20... 89 °C	20 °C
TFlowmax	Maximum flow temperature	21... 90 °C	50 °C
Interval	Mixer interval	1... 20s	4 s
HC pump	Heating circuit pump output selection	system dependent	system dependent

Adjustment channel	Description	Adjustment range/ selection	Factory setting
Mixer open	Output selection mixer open	system dependent	system dependent
Mixer closed	Output selection mixer closed	system dependent	system dependent
Sen. flow	Flow sensor selection	system dependent	system dependent
Sen. outd.	Outdoor sensor selection	system dependent	system dependent
Day corr.	Correction for day operation	-5 ... +45K	0K
Night corr.	Correction for night operation	-20 ... +30K	-5K
Timer	Timer option	Yes, No	No
Timer	Timer submenu	-	-
Mode	Correction mode	Day/Night, Day/Off	Day/Night
Summer oper.	Summer operation option	Yes, No	No
Summer oper.	Summer operation submenu	-	-
Mode	Summer operating mode	Day/Night, Day	Day
TDay off	Summer temperature day	0 ... 40 °C	20 °C
TNight off	Summer temperature night	0 ... 40 °C	14 °C
Daytime on	Day time frame on	00:00 ... 23:45	00:00
Daytime off	Day time frame off	00:00 ... 23:45	00:00
Remote access	Remote access option	Yes, No	No
Remote access	Remote access submenu	-	-
Mode	Remote access mode	BAS, Fern, App	BAS
Sen. BAS	Allocation operating mode switch input	all inputs type = BAS	-
Sen. RC	Allocation remote control input	all inputs type = Fern	-
Room therm.	Room thermostats submenu	-	-
Room therm. 1 ... 5	Room thermostat option (1 ... 5)	Yes, No	No
Type	Room thermostat type selection	Sensor, Switch	Sensor
Sensor RTH	RTH input allocation	system dependent	system dependent
TAmbSet	Set room temperature	10 ... 30 °C	18 °C
Hysteresis	RTH hysteresis	0.5 ... 20.0K	0.5K
Timer	RTH timer	Yes, No	No
Correction	Correction value	1 ... 20K	5K
Relay	RTH relay selection	system dependent	system dependent

Adjustment channel	Description	Adjustment range/ selection	Factory setting
RTH	Room thermostat	Activated, Deactivated	Activated
HC off	Heating circuit off option	Yes, No	Yes
Backup heating	Backup heating option	Yes, No	No
Backup heating	Backup heating submenu	-	-
Mode	Backup heating mode selection	Therm., Zone, On/Off	Therm.
Output	Output selection	system dependent	system dependent
Sensor 1	Allocation reference sensor 1	system dependent	system dependent
Sensor 2	Allocation reference sensor 2 (if mode = Zone)	system dependent	system dependent
ΔTon	Switch-on temperature difference	-15.0 ... 44.5K	5.0K
ΔToff	Switch-off temperature difference	-14.5 ... 45.0K	15.0K
Loading pump	Boiler loading pump option	Yes, No	No
Start. opt.	Starting optimisation option	Yes, No	No
Time	Time starting optimisation	0 ... 300 min	60 min
Stopp. opt.	Stopping optimisation option	Yes, No	No
Time	Time stopping optimisation	0 ... 300 min	60 min
Solar off	Solar off option	Yes, No	No
Store	Allocation solar store	all solar stores	-
Stset	Set temperature option	Yes, No	No
SFB off	Solid fuel boiler off option	Yes, No	No
SFB	Allocation solid fuel boiler	all solid fuel boilers	-
DHW priority	DHW priority option	Yes, No	No
Chimney sweeper	Chimney sweeper option	Yes, No	Yes
Antifreeze	Antifreeze option	Yes, No	No
Sensor	Antifreeze sensor	Flow, Outdoor	Flow
TAntifr	Antifreeze temperature	-20 ... +10 °C	+5 °C
TFlowset	Set flow temperature antifreeze	20 ... 50 °C	20 °C
Special oper.	Special operation option	Yes, No	No

Adjustment channel	Description	Adjustment range/ selection	Factory setting
Special oper.	Special operation submenu	-	-
Type	Special operation variant	Cooling, Heat dump	
Output	Output selection	system dependent	system dependent
Mode	Cooling mode	Outdoor, Ext. switch, Both	-
Sensor	Switch input selection	-	-
Inverted	Inverted switching option	Yes, No	No
TDay off	Outdoor temperature cooling	20... 40 °C	20 °C
Cooling system	Cooling system submenu	-	-
Mode	Mode	Linear, Constant	Constant
TFlow	Cooling flow temperature	5... 25 °C	20 °C
TOutdoor 1	Lower outdoor temperature	15... 45 °C	20 °C
TFlow 1	Lower set flow temperature	5... 25 °C	20 °C
TOutdoor 2	Upper outdoor temperature	15... 45 °C	40 °C
TFlow 2	Upper set flow temperature	5... 25 °C	10 °C
TFlowmin	Minimum flow temperature	5... 29 °C	10 °C
TFlowmax	Maximum flow temperature	6... 30 °C	25 °C
Timer	Timer option cooling	Yes, No	No
tOn	Switch-on time cooling	00:00... 23:45	00:00
tOff	Switch-off time cooling	00:00... 23:45	00:00
Dew point switch	Dew point switch (DPS) option	Yes, No	No
Sensor	Allocation DPS input	system dependent	system dependent
Output	Output selection	system dependent	system dependent
Sensor	Allocation heat dump sensor	system dependent	system dependent
Ton	Switch-on temperature heat dump	25... 95 °C	85 °C
Toff	Switch-off temperature heat dump	20... 90 °C	50 °C
TFlowset	Set flow temperature heat dump	5... 90 °C	50 °C
Energy saving	Energy saving operation option	Yes, No	No
Energy saving	Energy saving operation submenu	-	-
Sen. return	HC return sensor allocation	system dependent	system dependent

Adjustment channel	Description	Adjustment range/ selection	Factory setting
ΔToff	Switch-off temperature difference energy saving operation	1... 49K	4K
Break	Break time energy saving operation	0... 60 min	15 min
Runtime	Runtime energy saving operation	0... 60 min	2min
Funct.	De/activation of the heating circuit	Activated, Deactivated, Switch	Activated
Sensor	Switch input selection	-	-
Save/Delete function	Save or delete function	-	-

### 10.3 Optional functions

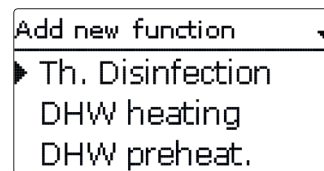

In this menu, optional functions can be selected and adjusted for the heating part of the arrangement.

The kind and number of optional functions offered depends on the previous adjustments.



#### Note

For further information about adjusting optional functions, see page 14.

In the **Demand** submenu, the modes **Standard** and **Demand** are available. If **Standard** is selected, the output can be adjusted. If **Demand** is selected, a demand has to be activated and adjusted in the **Heating/Shared rel.** first. If **Adjustment values** is selected, the **Heating/Shared rel./Demand** will open.



#### Note

For information on the output selection see page 16.

## Thermal disinfection

Th. Disinfection ▾

▶ Demand R11

Circulating pump

Sensor S11

This function helps to contain the spread of Legionella in DHW stores by systematically activating the backup heating.

One **Sensor** and one output or **Demand** respectively can be selected for this function.

For thermal disinfection, the temperature at the allocated sensor has to be monitored. Protection is ensured when, during the **Monitoring period**, the **Disinfection temperature** is continuously exceeded for the entire **Disinfection period**.

The monitoring period starts as soon as the temperature at the allocated sensor falls below the disinfection temperature. If the monitoring period ends, the **Demand** will activate the backup heating. The Disinfection period starts when the temperature at the allocated Sensor exceeds the disinfection temperature.

Thermal disinfection can only be completed when the Disinfection temperature is exceeded for the duration of the Disinfection period without any interruption.

The parameter **Cancellation** is used for adjusting the period after which the non-completed backup heating will be cancelled. If the backup heating is cancelled, an error message will be displayed.

### Starting time delay

Th. Disinfection ▾

▶  Start. time

Start. time 20:00

Hyst. off 5 K

If the **Starting delay** option is activated, a starting time for the thermal disinfection with starting delay can be adjusted. The activation of the backup heating is then delayed until that starting time after the monitoring period has ended.

If the monitoring period ends, for example, at 12:00 o'clock, and the starting time has been set to 18:00, the reference relay will be energised with a delay of 6 hours at 18:00 instead of 12:00 o'clock.

## Heating/Opt. functions/Add new function/Th. Disinfection

Adjustment channel	Description	Adjustment range / selection	Factory setting
Demand	Demand relay selection	system dependent	system dependent
Circulating pump	Circulating pump option	Yes, No	No
Output	Circulating pump output selection	system dependent	system dependent
Sensor	Disinfection sensor selection	system dependent	system dependent
Interval	Monitoring period	0 ... 30, 1 ... 23 (dd:hh)	1d 0h
Temperature	Disinfection temperature	45 ... 90 °C	60 °C
Duration	Disinfection period	0.5 ... 24.0 h	1.0 h
Cancellation	Cancellation option	Yes, No	No
Cancellation	Cancellation interval	1.0 ... 48.0 h	2.0 h
Start. time	Starting delay option	Yes, No	No
Start. time	Starting time	00:00 ... 23:30	20:00
Hyst. off	Switch-off hysteresis	2 ... 20 K	5 K
Hyst. on	Switch-on hysteresis	1 ... 19 K	2 K
TD hold. off	Thermal disinfection off when holiday function is active	Yes, No	No
BAS	Operating mode switch option	Yes, No	No
Sensor	Allocation operating mode switch input	system dependent	system dependent
Funct.	Activation / Deactivation	Activated, Deactivated, Switch	Activated
Sensor	Switch input selection	-	-
Save / Delete function	Save or delete function	-	-

### DHW heating

DHW heating ▾

▶ Demand R11

Loading pump

Mode Therm.

The **DHW heating** is used for demanding a backup heating for heating the DHW store. If the **Loading pump** option is activated, another adjustment channel will appear, in which an output can be allocated to the loading pump. The allocated output will switch on and off with the demand relay.

If the **Overrun time** option is activated, another adjustment channel will appear, in which the overrun time can be adjusted. If the overrun time option is activated, the loading pump relay will remain switched on for the adjusted duration after the demand relay has been switched off.

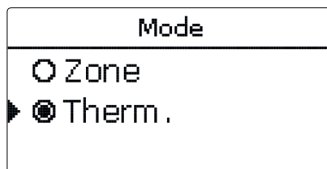

For the DHW heating, 2 modes are available:

### Thermal mode

The allocated demand relay will be switched on when the temperature at the allocated **Sensor 1** falls below the adjusted switch-on temperature. If the temperature at the allocated sensor 1 exceeds the adjusted switch-off temperature, the relay will be switched off.

### Zone mode

If the zone mode has been selected, another sensor can be allocated in the channel **Sensor 2**. The switch-on, or the switch-off conditions respectively, then have to be fulfilled at both sensors in order for the output to be switched on or off.

When the **Timer** option is activated, a timer is indicated in which time frames for the function can be adjusted.

If **SFB off** is activated, DHW heating will be suppressed when a selected solid fuel boiler is active.

If **Solar off** is activated, DHW heating will be suppressed when a selected store is being loaded.

If the **Set temperature** option is activated, the DHW heating will only be suppressed when the store temperature exceeds the **Set store temperature**.

With the **Manual heating** option, DHW heating can be activated outside the adjusted time frame once by means of a switch, if the temperature has fallen below the switch-off value.



### Note

For information on timer adjustment see page 12.

With the **BAS off** option, DHW heating can be switched from automatic mode to off by means of the operating mode switch.

## Heating/Opt. functions/Add new function/DHW heating

Adjustment channel	Description	Adjustment range/selection	Factory setting
Demand	Output selection demand	system dependent	-
Loading pump	Loading pump option	Yes, No	No
Output	Output selection loading pump	system dependent	-
Overrun time	Overrun option	Yes, No	No
Duration	Overrun time	1...10 min	1 min
Mode	Operating mode	Zone, Therm.	Therm.
Sensor 1	Allocation reference sensor 1	system dependent	system dependent
Sensor 2	Allocation reference sensor 2 (if mode = Zone)	system dependent	system dependent
Ton	Switch-on temperature	0...94 °C	40 °C
Toff	Switch-off temperature	1...95 °C	45 °C
Timer	Timer option	Yes, No	No
Timer	Timer	-	-
Man. heating	Manual heating option	Yes, No	No
Sensor	Allocation switch input	system dependent	system dependent
DHW holid. off	DHW heating off when holiday function is active	Yes, No	No
BAS off	Operating mode switch off option	Yes, No	No
Solar off	Solar off option	Yes, No	No
Store	Allocation solar store	all solar stores	-
Stset	Set temperature option	Yes, No	No
SFB off	Solid fuel boiler off option	Yes, No	No
SFB	Allocation solid fuel boiler	all solid fuel boilers	-
Funct.	Activation / Deactivation	Activated, Deactivated, Switch	Activated
Sensor	Switch input selection	-	-
Save/Delete function	Save or delete function	-	-

## DHW preheating

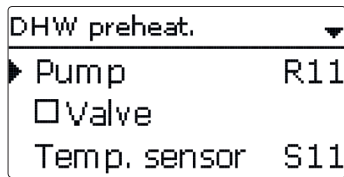

The **DHW preheating** function uses heat from a buffer store to heat the cold water inlet of the DHW store.

The controller monitors the flow rate at the selected **Flow rate sensor**. If a flow rate is detected, the pump will switch on with the **Starting speed**.

If the temperature at the **Temperature sensor** selected exceeds the adjusted **DHW maximum temperature**, the speed will be decreased by the **Increment** value. The interval to the next measurement and adaptation can be adjusted by means of the parameter **Delay**.

If the DHW maximum temperature is not reached after the delay time has elapsed, the speed will be increased by the increment value. The speed will not be increased or decreased respectively within the **Hysteresis**.

If the  **$\Delta T$  function** is activated, the pump will switch on only if  $\Delta T_{on}$  is exceeded, and switch off if the temperature difference falls below  $\Delta T_{off}$ .

If the **Valve** option is activated, the output selected will be activated when the pump is activated.

### Heating/Opt. functions/Add new function/DHW preheat.

Adjustment channel	Description	Adjustment range/selection	Factory setting
Pump	Output selection pump	system dependent	-
Valve	Valve option	Yes, No	No
Valve	Output selection valve	system dependent	-
Temp. sensor	Temperature sensor	system dependent	-
Sen. flow rate	Flow rate sensor	IMP1 ... IMP3, Ga1, Ga2, Gd1, Gd2, FR1 (FlowRotor)	-
Tmax. DHW	DHW maximum temperature	20 ... 90 °C	60 °C
Starting speed	Starting speed DHW preheating	20 ... 100%	50%

Adjustment channel	Description	Adjustment range/selection	Factory setting
Increment	Increment speed adaptation	1 ... 100%	10%
Hysteresis	Hysteresis speed adaptation	0.5 ... 10.0K	5.0K
Delay	Delay time	1 ... 10 s	5 s
$\Delta T$ function	Activation $\Delta T$ function	Yes, No	No
$\Delta T_{on}$	Switch-on temperature difference	1.0 ... 50.0K	5.0K
$\Delta T_{off}$	Switch-off temperature difference	0.5 ... 49.5K	3.0K
Sen. source	Heat source sensor selection	system dependent	-
Sen. sink	Heat sink sensor selection	system dependent	-
Func.	Activation / Deactivation	Activated, Deactivated, Switch	Activated
Sensor	Switch input selection	-	-
Save / Delete function	Save or delete function	-	-

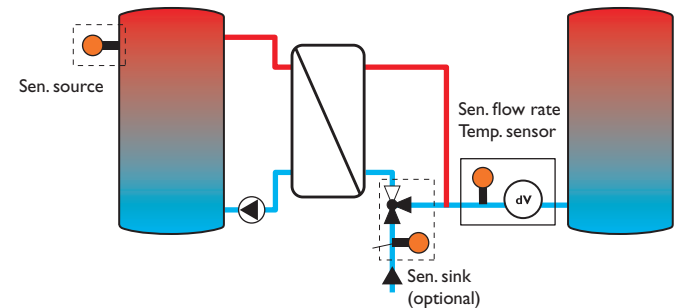

## 10.4 Screed drying

This function is used for time- and temperature-controlled screed drying in selectable heating circuits.

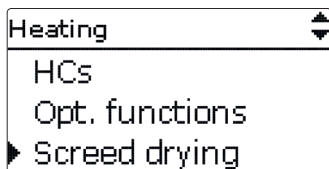

The heating circuits can be selected in the **Heating/Screed drying** menu. At the end of this menu, the function can be triggered by using **Start**.

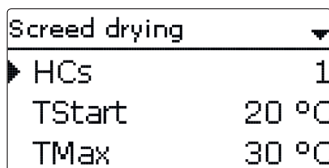

The controller will automatically change to the screed drying status menu. The current **Phase** will be indicated on the display and the **Remaining time** will be indicated as a countdown (dd:hh). During this process, the directional pad is flashing green.

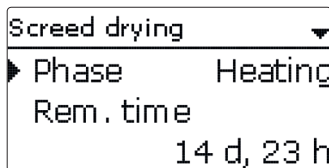

At the end of the menu, **Cancel** will be indicated instead of start. If Cancel is selected, screed drying will be cancelled immediately. For this reason, a security enquiry will appear. If you wish to cancel the screed drying function, confirm the security enquiry.

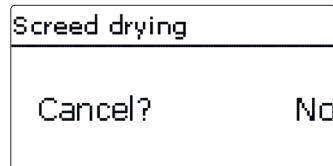

At the beginning of the screed drying function, the heating circuits selected are put into operation for the adjusted **Rise time** with the Start temperature as the set flow temperature. Afterwards, the set flow temperature increases in steps by the adjustable Rise value for the duration of the adjustable Rise time until the Holding temperature is reached. After the Holding time has elapsed, the set flow temperature is reduced in steps until the start temperature is reached again.

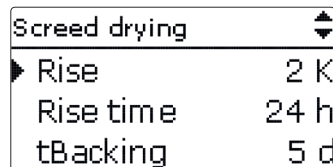

If the set flow temperature is not reached within 24 hours or after the rise time respectively, or if it is constantly exceeded, the screed drying function will be cancelled.

The heating circuit switches off and an error message is displayed. The directional pad flashes red.

Error 1: flow sensor defective

Error 2: the flow temperature is higher than the maximum flow temperature + 5 K for over 5 min

Error 3: the flow temperature is higher than the holding temperature + rise value for over 30 min

Error 4: the flow temperature is higher than the set flow temperature + rise value for over 2 h

Error 5: the flow temperature is lower than the set flow temperature - rise value for over a rise time period

During screed drying of the heating circuits selected, the other heating circuits run corresponding to their operating modes.



Button  can be used any time for changing to the status or main menu of the controller in order to carry out adjustments.

When the screed drying function has been successfully completed, the corresponding heating circuits will change to their operating modes selected.

Screed drying will automatically be deactivated. The chimney sweeper function will be activated in all heating circuits.



#### Note

Make sure the heating circuits are supplied with heat from a heat source (backup heating).



#### Note

If an SD card has been inserted into the slot, a screed protocol will be generated.

### Heating/Screed drying

Adjustment channel	Description	Adjustment range/selection	Factory setting
HC	Heating circuit selection	HC 1...7	system dependent
TStart	Start temperature	10...30 °C	20 °C
TMax	Holding temperature	20...60 °C	30 °C
Rise	Rise value	1...10K	2K
Rise time	Rise duration	1...24 h	24 h
tBacking	Tmax holding time	1...20 d	5 d
Start	Activation/Deactivation	Yes, No	No

## 11 HQM

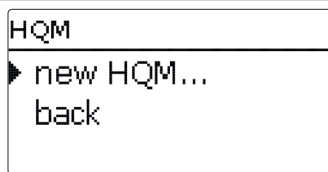

In the **HQM** menu, up to 7 internal heat quantity measurements can be activated and adjusted.

By selecting the menu item **new HQM...**, a new heat quantity measurement can be activated.

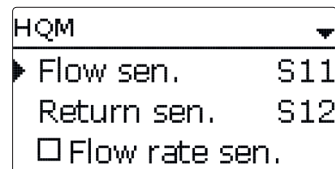

A menu will open in which all adjustments required for the heat quantity measurement can be made.

If the **Flow rate sensor** option is activated, an impulse input or, if available, a Grundfos Direct Sensor™ or a FlowRotor can be selected. The FlowRotor and the Grundfos Direct Sensors™ will only be available if they have been previously registered in the **Inputs/Modules** menu. The impulse rate must be adjusted in that menu as well.

If the **Flow rate sensor** option is deactivated, the controller will calculate the heat quantity by means of a fixed flow rate value. This is called heat quantity balancing. For this purpose, the flow rate must be read from the flowmeter at 100% pump speed and adjusted in the adjustment channel **Flow rate**. In addition to that, a **Relay** must be allocated. Heat quantity balancing is in effect whenever the allocated relay is active.

In the adjustment channel **Fluid type** the heat transfer fluid must be selected. If either propylene glycol or ethylene glycol is selected, the adjustment channel **Concentration** is indicated in which the antifreeze ratio of the heat transfer fluid can be adjusted.

If a calorimeter is being configured for the first time or after the overall quantity has been reset, the parameter **Carryover** will appear. A former value which is to be added to the overall quantity, can be entered.

When the **Alternative unit** is activated, the controller will convert the heat quantity into the quantity of fossil fuels (coal, oil or gas) saved, or the CO<sub>2</sub> emission saved respectively. The alternative **Unit** can be selected. A **Conversion factor** must be adjusted for the calculation. The conversion factor depends on the arrangement in use and has to be determined individually.

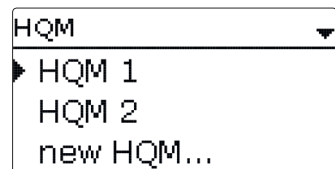

Heat quantity measurements already saved will appear in the HQM menu above the menu item **new HQM...** in numerical order.

If a heat quantity measurement already saved is selected, the above mentioned submenu with all adjustment values will re-open.

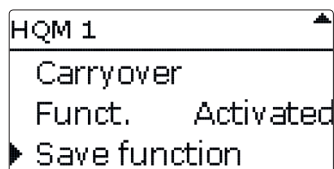

At the end of each HQM submenu, the menu items **Function** and **Save function** are available.

In order to save a heat quantity measurement, select **Save function** and confirm the security enquiry by selecting **Yes**. In heat quantity measurements already saved, the menu item **Delete function** will appear instead.

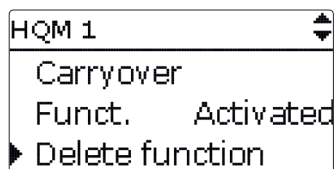

In order to delete a heat quantity measurement already saved, select **Delete function** and confirm the security enquiry by selecting **Yes**. The heat quantity measurement deleted will disappear from the list and become available for selection in the **new HQM...** menu again.

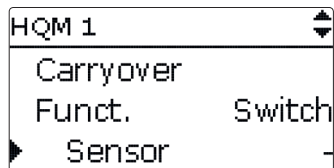

With the menu item **Function**, a heat quantity measurement already saved can be temporarily deactivated or re-activated respectively. In this case, all adjustments will remain stored.

By selecting **Switch**, the heat quantity measurement can be activated or deactivated respectively by means of an external switch. If **Switch** is selected, the channel

**Sensor** will appear. In this channel, the sensor input to which the switch is to be connected can be allocated to the function.

### HQM/new HQM...

Adjustment channel	Description	Adjustment range/ selection	Factory setting
Sen. flow	Flow sensor selection	system dependent	system dependent
Sen. ret.	Return sensor selection	system dependent	system dependent
Sen. flow rate	Flow rate sensor option	Yes, No	No
Sen. flow rate	Flow rate sensor selection	IMP1 ... IMP3, Ga1, Ga2, Gd1, Gd2, FR1	-
Fl.rate	Flow rate (only if Sen. flow rate = No)	1.0 ... 500.0 l/min	3.0 l/min
Relay	Relay selection	system dependent	-
Fluid type	Heat transfer fluid	Tyfocon LS, Propyl., Ethyl., Water	Water
Concentr.	Glycol concentration in the heat transfer fluid (only if fluid type = Propyl. or Ethyl.)	20 ... 70 %	40 %
Alternative unit	Alternative unit option	Yes, No	No
Carryover	Carryover value (for the first-time configuration or after a HQM reset only)	-	-
Unit	Alternative display unit	Coal, Gas, Oil, CO <sub>2</sub>	CO <sub>2</sub>
Factor	Conversion factor	0.0000001 ... 100.0000000	0.5000000
Funct.	Activation/Deactivation	Activated, Deactivated	Activated

## 12 Basic settings

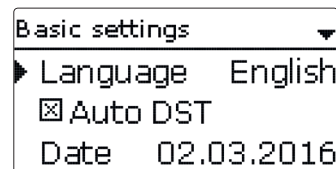

In the **Basic settings** menu, all basic parameters for the controller can be adjusted. Normally, these settings have been made during commissioning. They can be subsequently changed in this menu.

## Basic settings

Adjustment channel	Description	Adjustment range / selection	Factory setting
Language	Selection of the menu language	Deutsch, English, Français, Italiano, Español, Nederlands, Suomi	Deutsch
Auto DST	Daylight savings time selection	Yes, No	Yes
Date	Adjustment of the current date	01.01.2001 ... 31.12.2099	01.01.2012
Time	Adjustment of the current time	00:00 ... 23:59	-
Temp. unit	Temperature unit	°C, °F	°C
Flow unit	Volume unit	Gallons, Liter	Liter
Press. unit	Pressure unit	psi, bar	bar
Energy unit	Energy unit	Wh, BTU	Wh
Blocking protection	Blocking protection submenu	-	-
Start. time	Blocking protection starting time	00:00 ... 23:59	12:00
Runtime	Blocking protection runtime	1 ... 30 s	10 s
Reset	back to factory setting	Yes, No	No
Scheme	Scheme selection	0000 ... 9999	0000

## 13 SD card

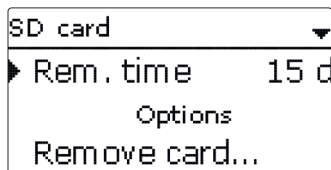

The controller is equipped with an SD card slot for SD memory cards.

With an SD card, the following functions can be carried out:

- Logging measurement and balance values. After the transfer to a computer, the values can be opened and visualised, e. g. in a spreadsheet.
- Store adjustments and parameterisations on the SD card and, if necessary, retrieve them from there.
- Running firmware updates on the controller.

## Firmware updates

The current software can be downloaded from [www.resol.com/firmware](http://www.resol.com/firmware). When an SD card with a firmware update is inserted, the enquiry **Update?** is indicated on the display.

→ To run the update, select **Yes** and confirm by pressing button **5**.

The update is run automatically. The indication **Please wait** and a progress bar appear on the display. When the update has been completed, the controller will automatically reboot and run a short initialisation phase.



### Note

Only remove the card when the initialisation phase has been completed and the main menu is indicated on the controller display!

→ To skip the update, select **No**.

The controller starts normal operation.



### Note

The controller will only recognise a firmware update file if it is stored in a folder named **RESOL** on the first level of the SD card.

→ Create a folder named **RESOL** on the SD card and extract the downloaded ZIP file into this folder.

## Starting the logging

→ Insert the SD card into the slot.

→ Adjust the desired logging type and interval.

Logging will start immediately.

## Completing the logging process

→ Select the menu item **Remove card...**

→ After **Remove card** is displayed, remove the card from the slot.

When **Linear** is adjusted in the logging type adjustment channel, data logging will stop if the capacity limit is reached. The message **Card full** will be displayed.

If **Cyclic** is adjusted, the oldest data logged onto the SD card will be overwritten as soon as the capacity limit is reached.



### Note

Because of the increasing size of the data packets, the remaining logging time does not decrease linearly. The data packet size can increase, e. g. with the increasing operating hours value.

## Storing controller adjustments

→ To store the controller adjustments on an SD card, select the menu item **Save adjustments**.

While the adjustments are being stored, first **Please wait**, then **Done!** will be indicated on the display. The controller adjustments are stored as a .SET file on the SD card.

## Loading controller adjustments

→ To load controller adjustments from an SD card, select the menu item **Load adjustments**.

The **file selection** window will appear.

→ Select the desired .SET file.

While the adjustments are being loaded, first **Please wait**, then **Done!** will be indicated on the display.



### Note

To safely remove the SD card, always select the menu item **Remove card...** before removing the card.

## SD card

Adjustment channel	Description	Adjustment range/ selection	Factory setting
Remove card...	Safely remove card	-	-
Save adjustments	Save adjustments	-	-
Load adjustments	Load adjustments	-	-
Logging interval	Logging interval	00:01 ... 20:00 (mm:ss)	01:00
Logging type	Logging type	Cyclic, Linear	Linear

## 14 Manual mode

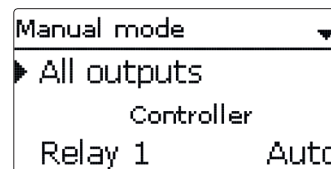

In the **Manual mode** menu, the operating mode of all outputs in the controller and in modules connected can be adjusted.

All outputs are displayed in numerical order, first those of the controller, then those of the individual modules connected. Modules are listed in numerical order.

In the **All outputs...** menu, all outputs can be switched off (Off) or set to automatic mode (Auto) at once:

Off = Output is switched off (manual mode)

Auto = Output is in automatic mode

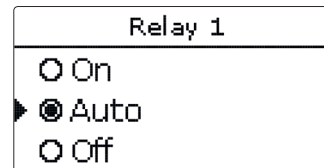

The operating mode can be selected for each individual output, too. The following options are available:

Off = Output is switched off (manual mode)

On = Output is active at 100% speed (manual mode)

Auto = Output is in automatic mode



### Note

After service and maintenance work, the relay mode must be set back to **Auto**. Normal operation is not possible in manual mode.

## Manual mode

Adjustment channel	Description	Adjustment range/selection	Factory setting
Relay 1...X	Operating mode relay	On,Auto,Off	Auto
Output A...D	Operating mode signal output	On,Auto,Off	Auto
Demand 1 (2)	Operating mode demand	Max,Auto,Min,Off	Auto
All outputs...	Selection operating mode of all relays	Auto,Off	Off

## 15 User code

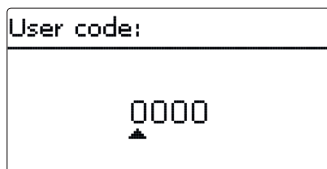

In the **User code** menu, a user code can be entered. Each number of the 4-digit code must be individually adjusted and confirmed. After the last digit has been confirmed, the menu automatically jumps to the superior menu level.

To access the menu areas of the installer level, the installer user code must be entered:

Installer: 0262

For safety reasons, the user code should generally be set to the customer code before the controller is handed to the customer!

Customer: 0000

## 16 Inputs/Modules

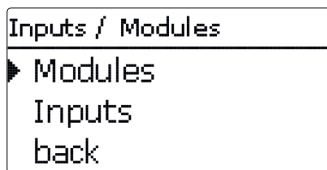

In the **Inputs/Modules** menu, external modules can be registered and sensor offsets be adjusted.

## 16.1 Modules

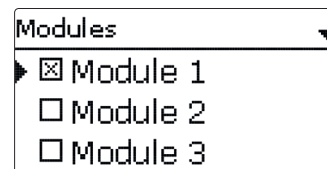

In this menu, up to 5 external modules can be registered.

All modules connected and acknowledged by the controller are available.

➔ To register a module, select the corresponding menu item by pressing button

5.

The checkbox indicates the selection. If a module is registered, all its sensor inputs and relay outputs will be available in the corresponding controller menus.

### Inputs/Modules/Modules

Adjustment channel	Description	Adjustment range/selection	Factory setting
Module 1...5	Registering external modules	-	-

## 16.2 Inputs

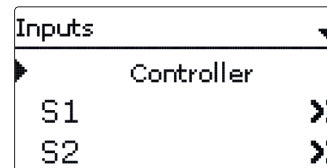

In this submenu, the type of the sensor connected can be adjusted for each individual input. The following types can be selected:

- S1...S12: Switch, Fern (remote control), BAS (operating mode switch), Pt1000, Pt500, KTY, None
- S13/IMP1...S15/IMP3: Impulse, Switch, Fern (remote control), BAS (operating mode switch), Pt1000, Pt500, KTY, None
- CS10: A...K
- Ga1, Ga2: RPS,VFS, None
- Gd1, Gd2: RPD,VFD, None
- FR1: DN20, DN25, DN32, None

**ATTENTION! System damage!**

Selecting the wrong sensor type will lead to unwanted control behaviour. In the worst case, system damage can occur!

→ **Make sure that the right sensor type is selected!**

If **KTY**, **Pt500** or **Pt1000** is selected, the channel **Offset** will appear, in which an individual offset can be adjusted for each sensor.

→ In order to select a sensor for the offset adjustment, select the corresponding menu item by pressing button ⑤.

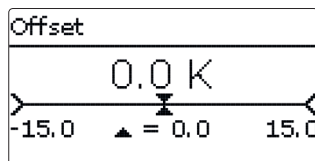

→ To adjust the sensor offset, select the desired value by pressing buttons ② or ④, then confirm by pressing button ⑤.

**Note**

If a sensor is used as the temperature sensor of a function, the sensor types **Switch**, **Fern**, **BAS**, **Impulse** and **none** will not be available for the corresponding input.

**ATTENTION! Damage to the device!**

Sensor inputs which have been set to the sensor type switch can only be used for connecting potential-free switches.

→ **Make sure no voltage is applied!**

If **Switch** is selected, the **Inverted** option will appear and can be used for inverting the behaviour of the switch.

**CS sensor offset**

If a CS10 irradiation sensor is to be connected, an offset has to be carried out before the connection is made.

To carry out the offset, proceed as follows:

→ Adjust the CS type in the **Type** channel.

→ Select the **Offset** channel.

→ Confirm the **Reset** enquiry with **Yes**.

→ Select **back** to return to the **Inputs** menu, then connect the CS sensor.

**Note**

When Grundfos Direct Sensors™ are used, connect the sensor ground common terminal block to PE (see page 7).

**Inputs/Modules/Inputs**

Adjustment channel	Description	Adjustment range/selection	Factory setting
S1 ... S12	Sensor input selection	-	-
Type	Sensor type selection	Switch, Fern, BAS, KTY, Pt500, Pt1000, None	Pt1000
Offset	Sensor offset	-15.0 ... +15.0 K	0.0 K
IMP1 ... IMP3	Impulse input selection	-	-
Type	Sensor type selection	Impulse, Switch, Fern, BAS, KTY, Pt500, Pt1000, None	Impulse
Inverted	Switch inversion (only when Type = Switch)	Yes, No	No
Vol./Imp.	Impulse rate	0.1 ... 100.0	1.0
CS10	CS10 input	-	-
Type	CS type	A ... K	E
Offset	Delete offset	Yes, No	No
Ga1, 2	Analogue Grundfos Direct Sensor™ 1, 2	-	-
Type	Grundfos-Direct-Sensor™ type	RPS, VFS, None	None
Max.	Maximum pressure (if Type = RPS)	0.0 ... 16.0 bar	6 bar
Min.	Minimum flow rate (if Type = VFS)	1 ... 399 l/min	2 l/min
Max.	Maximum flow rate (if Type = VFS)	2 ... 400 l/min	40 l/min
Gd1, 2	Digital Grundfos Direct Sensor™ 1, 2	-	-
Type	Grundfos-Direct-Sensor™ type	RPD, VFD, None	None
	if Type = VFD: Measuring range selection	10-200 l/min, 5-100 l/min, 2-40 l/min, 2-40 l/min (fast), 1-20 l/min, 1-12 l/min*	1-12 l/min

\* For the Inputs Gd1 and Gd2, the following sensor combinations are possible:

- 1 x RPD, 1 x VFD

- 2 x VFD, but with different measuring ranges only

## 17 Troubleshooting

If a malfunction occurs, a message will appear on the display of the controller.

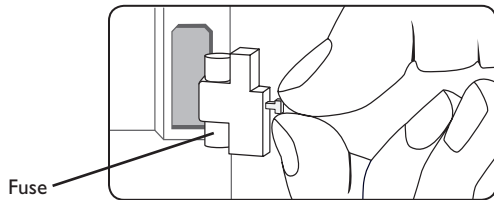

Directional pad flashes red.

Sensor fault. The message **!Sensor fault** instead of a temperature is shown on the sensor display channel.

Short circuit or line break.

Disconnected temperature sensors can be checked with an ohmmeter. Please check if the resistance values correspond with the table.

°C	°F	Ω Pt500	Ω Pt1000	Ω KTY	°C	°F	Ω Pt500	Ω Pt1000	Ω KTY
-10	14	481	961	1499	55	131	607	1213	2502
-5	23	490	980	1565	60	140	616	1232	2592
0	32	500	1000	1633	65	149	626	1252	2684
5	41	510	1019	1702	70	158	636	1271	2778
10	50	520	1039	1774	75	167	645	1290	2874
15	59	529	1058	1847	80	176	655	1309	2971
20	68	539	1078	1922	85	185	664	1328	3071
25	77	549	1097	2000	90	194	674	1347	3172
30	86	559	1117	2079	95	203	683	1366	3275
35	95	568	1136	2159	100	212	693	1385	3380
40	104	578	1155	2242	105	221	702	1404	3484
45	113	588	1175	2327	110	230	712	1423	3590
50	122	597	1194	2413	115	239	721	1442	3695

### WARNING! Electric shock!



Upon opening the housing, live parts are exposed!

→ **Always disconnect the device from power supply before opening the housing!**

The controller is protected by a fuse. The fuse holder (which also holds the spare fuse) becomes accessible when the cover is removed. To replace the fuse, pull the fuse holder from the base.

The display is permanently off.

Press button **5**. Display illuminated?

no

yes

Controller has been in standby, everything o.k.

Check the power supply of the controller. Is it disconnected?

no

yes

The fuse of the controller could be blown. The fuse holder (which holds the spare fuse) becomes accessible when the cover is removed. The fuse can then be replaced.

Check the supply line and reconnect it.



### Note

For answers to frequently asked questions (FAQ) see [www.resol.com](http://www.resol.com).

Pump is overheated, but no heat transfer from the collector to the store, flow and return have the same temperature; perhaps also bubbling in the lines.

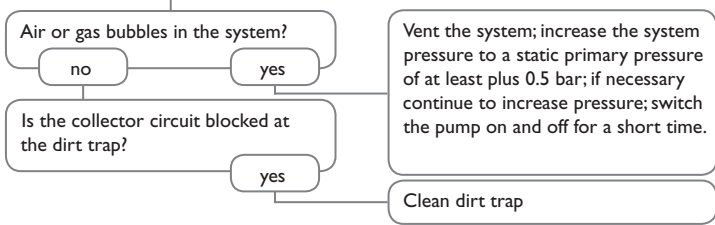

Pump starts up very late.

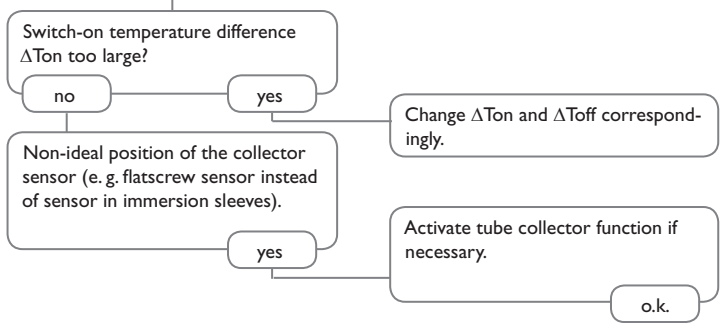

Pump starts for a short moment, switches off, switches on again, etc.

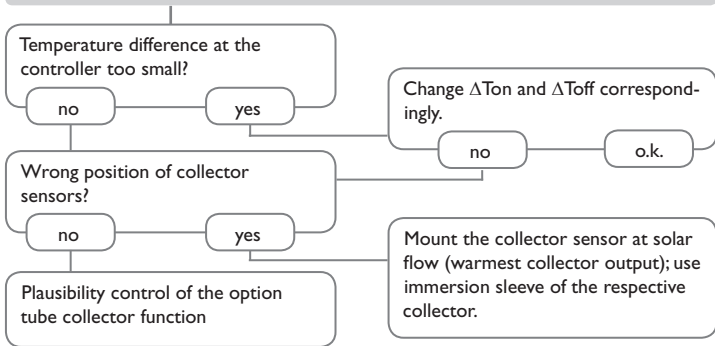

The temperature difference between store and collector increases enormously during operation; the collector circuit cannot dissipate the heat.

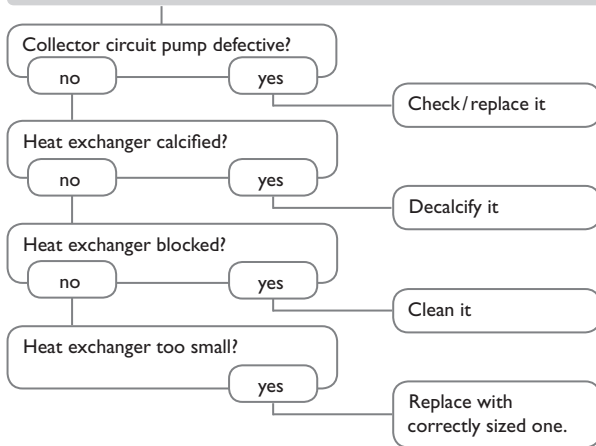



The solar circuit pump does not work, although the collector is considerably warmer than the store.

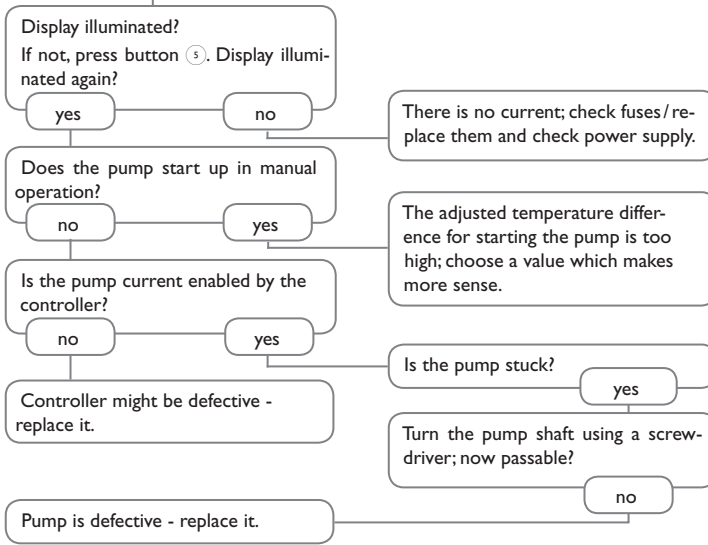

Stores cool down at night.

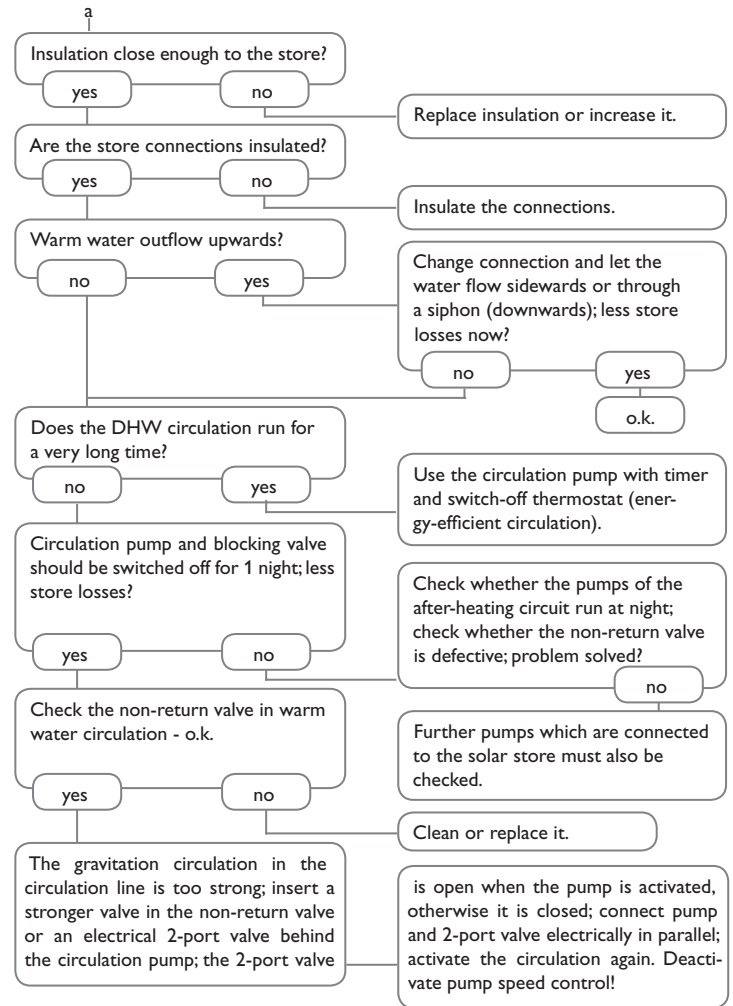
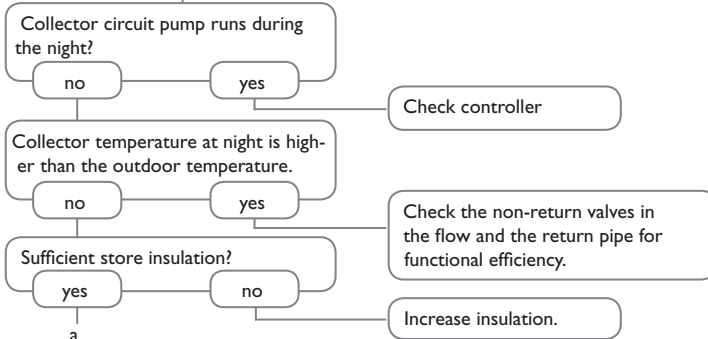



**DL3 Datalogger**

For visualisation via VBus.net, incl. SD card, mains adapter, network and VBus® cable.



**DL2 Datalogger**

For visualisation via VBus.net, incl. SD card and network cable, mains adapter and VBus® cable pre-connected.



**EM Extension Module**

Sensor and relay Extension module with 5 outputs and 6 inputs



**TS10 Dew point switch**

For condensation detection in a heating circuit used for cooling purposes.



**VFS/RPS & VFD/RPD Grundfos Direct Sensors™**

Analogue/digital sensors in different versions



**V40 Flowmeter**

The V40 is a measuring instrument for detecting the flow of water or water/glycol mixtures.



**AM1 Alarm module**

Alarm module for signalling system failures



**SD3/SDFK Smart Display/GA3 Large Display**

The SD3 Smart Display is used for visualising data issued by the controller: collector temperature, store temperature and energy yield of the solar thermal system.

The SDFK Smart Display indicates the solid fuel boiler temperature and the bottom/top store temperatures as well as the pump status.

The GA3 is a completely mounted large display module for visualisation of collector- and store temperatures as well as the heat quantity yield of the solar system.



**SP10 Overvoltage protection device**

Overvoltage protection device, suitable for mounting outdoors.



**VBus®/USB & VBus®/LAN interface adapters**

With the RESOL VBus®/USB interface adapter, the controller can be connected to the USB port of a PC via the VBus®.

The VBus®/LAN interface adapter is designed for the direct connection of the controller to a PC or router. It enables easy access to the controller via the local network of the owner.



**Sensors**

The product range includes high-precision platinum temperature sensors, flatscrew sensors, outdoor temperature sensors, indoor temperature sensors, cylindrical clip-on sensors, also as complete sensors with immersion sleeve.

<b>Zahlen</b>		
0-10 V boiler control .....	73	DHW priority, heating circuit .....
<b>A</b>		Drainback option .....
Antifreeze function .....	81	<b>E</b>
Antifreeze, solar optional function .....	54	Electrical connection .....
App 80		Energy saving operation, heating circuit .....
<b>B</b>		Error messages .....
Backup heating, heating circuit .....	80	46
Backup heating suppression .....	55	Error messages, acknowledgement of .....
Boiler control .....	73	46
Bypass, solar optional function .....	51	Error relay .....
<b>C</b>		<b>F</b>
Chimney sweeper function .....	81	Flow rate monitoring .....
Circulation .....	68	Function block .....
Collector cooling, Cooling mode .....	56	Fuse, replacing of .....
56		<b>H</b>
Collector emergency temperature .....	48	Heat dump .....
Commissioning menu .....	19	Heat dump, heating circuit .....
Condensation detection .....	82	Heating circuit mixer .....
Controller adjustments, loading of .....	92	Heating circuit pump .....
Controller adjustments, storing of .....	92	Heating curve .....
Cooling mode .....	56	Heat quantity measurement .....
Cooling via the heating circuit .....	82	Holiday function .....
Correction modes .....	80	<b>I</b>
Countdown .....	81	Index .....
CS bypass .....	52	Interval .....
<b>D</b>		Irradiation switch .....
Data logging .....	91	<b>M</b>
Day correction .....	76	Manual mode .....
Day/Night operation .....	79	Maximum flow temperature .....
Day operation .....	80	Maximum store temperature .....
Dew point switch .....	82	Minimum collector limitation .....
DHW heating .....	85	Minimum flow temperature .....
DHW preheating .....	87	Mixer, optional arrangement function .....
		Mixer runtime .....

Modulating heating control.....	75	Starting time.....	80
Modules, registration of.....	93	Start temperature.....	88
Mounting.....	5	Store cooling, Cooling mode.....	56
<b>N</b>		Store sequence control.....	49
Night correction.....	76	Successive loading.....	50
Night operation.....	79	System cooling, Cooling mode.....	61
<b>O</b>		<b>T</b>	
Offset.....	94	Target temperature, solar optional function.....	54
Operating mode, outputs.....	92	Technical data.....	4
Operating mode switch.....	80	Thermal disinfection.....	85
Output selection.....	16	Thermostat function.....	70
<b>P</b>		Timer.....	12
Parallel relay, solar optional function.....	55	Tube collector function.....	53
Priority logic.....	48	Twin pump.....	58
<b>R</b>		<b>U</b>	
Registering external modules.....	93	User code.....	93
Remote access, heating circuit.....	79	<b>V</b>	
Remote control.....	76, 80	VBus 8	
Return mixing function.....	72	Virtual.....	73
Return preheating.....	69	<b>Z</b>	
Room control, heating circuit.....	78	Zone loading.....	65
Room control unit.....	80		
Room influence, heating circuit.....	77		
Room thermostat.....	78		
<b>S</b>			
Screed drying.....	84, 88		
Sensor offset.....	94		
Set flow temperature.....	76		
Set store temperature.....	48		
Shared relays.....	73		
Solid fuel boiler.....	67		
Special operation, heating circuit.....	81		
Spreaded loading.....	50		







Distributed by:

**RESOL – Elektronische Regelungen GmbH**

Heiskampstraße 10  
45527 Hattingen / Germany

Tel.: +49 (0) 23 24 / 96 48 - 0

Fax: +49 (0) 23 24 / 96 48 - 755

[www.resol.com](http://www.resol.com)

[info@resol.com](mailto:info@resol.com)

**Important note**

The texts and drawings in this manual are correct to the best of our knowledge. As faults can never be excluded, please note:

Your own calculations and plans, under consideration of the current standards and directions should only be basis for your projects. We do not offer a guarantee for the completeness of the drawings and texts of this manual - they only represent some examples. They can only be used at your own risk. No liability is assumed for incorrect, incomplete or false information and / or the resulting damages.

**Note**

The design and the specifications can be changed without notice.  
The illustrations may differ from the original product.

**Imprint**

This mounting- and operation manual including all parts is copyrighted. Another use outside the copyright requires the approval of **RESOL – Elektronische Regelungen GmbH**. This especially applies for copies, translations, micro films and the storage into electronic systems.

© **RESOL – Elektronische Regelungen GmbH**